

# ***RCBS***®

## **M500 MECHANICAL SCALE**

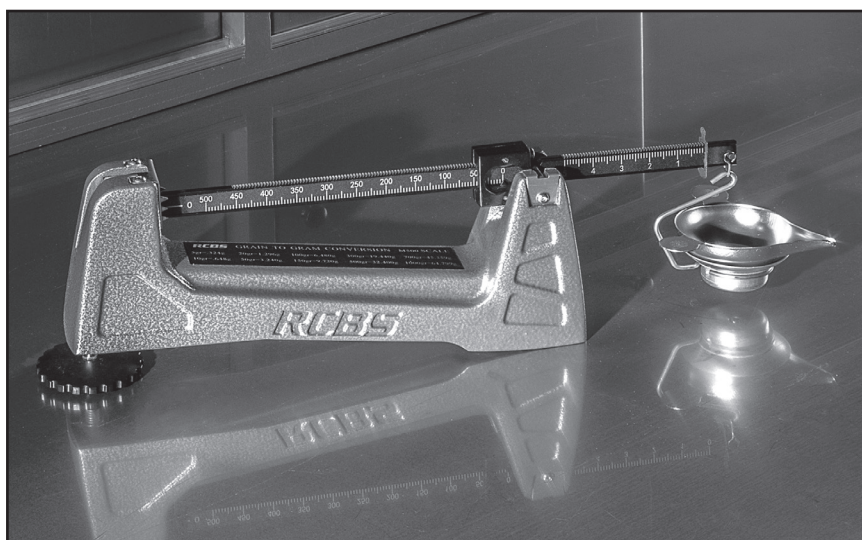

## **PRODUCT INSTRUCTIONS**

**151020**



## **WARNING!**

Before using this product, read and follow these instructions carefully. Failure to do so could result in serious injury or death, or property damage.

**If you have any questions while assembling or operating this product,  
call us at 1-800-379-1732 (U.S. or Canada)**

**Monday – Friday 5:00 a.m. – 5:00 p.m. Pacific Time**

**Or email us at [rcbs.tech@vistaoutdoor.com](mailto:rcbs.tech@vistaoutdoor.com)**

This manual contains important safety and operating information. Keep this as a permanent part of your reloading equipment. If lost, contact us for a replacement.

## **GUNPOWDER WARNINGS**



**WARNING!** Keep out of reach of children

- Store powders in their original package in a cool, dry environment free from wide temperature variations.
- Keep cans tightly sealed and labels intact.
- Mark date of purchase on can, for future reference. Use older stock first.
- Never use glass as a storage container. This may cause a “greenhouse effect” raising temperature in container and degrade the powder.
- Check cans and powder for signs of degradation. Many powders will exhibit a fine red-brown dust on the granules and/ or inside the container when this happens. If it does, do not use propellant; dispose of it properly in compliance with local regulations.
- DO NOT have more than one can of powder on the bench at one time. Powder Cans should be stored away from the bench to avoid picking up the wrong one.
- DO NOT use any powder unless its identity is positively known. The only positive identification is the manufacturer’s label on the original canister. Properly discard all mixed powders and those of uncertain identity in compliance with local regulations.
- If you use a powder measure, replace the lids on both the Powder Hopper and Powder Can after the Powder Hopper has been filled.
- When using a Powder Measure, settle the powder in the Powder Hopper before charging any cases. Throw and check the weight of at least ten (10) charges. This will assure you that the correct powder charge is being thrown.
- When you finish a reloading session, pour any remaining powder back into its original factory container. This will preserve the identity and shelf life of the powder.
- DO NOT smoke while reloading.

## **RELOADING SAFETY**

**NOTICE - This manual is not intended to provide comprehensive instructions or safety information on how to reload, or handle or use reloading components. Always read and thoroughly understand a reloading manual before attempting to reload ammunition.**

Reloading is an enjoyable and rewarding hobby when conducted safely. But, as with many hobbies, carelessness or negligence can make reloading hazardous. When reloading, always follow these safety guidelines to minimize the risk of personal injury or death.

- Always wear safety glasses.
- Understand what you are doing and why. Read handbooks and manuals on reloading. Talk to experienced reloaders. Write or call suppliers of equipment or components if you have questions or are in doubt.
- Read and understand all warnings and instructions accompanying your equipment and components. If you do not have written instructions, request a copy from the manufacturer. Keep instructions for future reference.
- Don’t rush or take short cuts. Establish a routine and follow it at a leisurely pace.
- Keep complete records of reloads. Label each box showing the date produced, and the type of primer, powder and bullet used.
- Do not smoke while reloading, or reload near sources of heat, sparks or flame.
- Observe good housekeeping in the reloading area. Keep tools and components neat, clean and orderly. Promptly and completely clean up any spills.
- Keep your hands and fingers away from “danger” spots and pinch-points where they might be injured.
- Keep all reloading equipment and components out of reach of children.

- Stay alert. Reload only when you can give your undivided attention. Do not reload when tired, ill, rushed or under the influence of drugs or alcohol.

Because RCBS® has no control over the choice, assembly or use of components or other reloading equipment, RCBS assumes no liability, expressed or implied, for the use of ammunition reloaded with this product.

### **LOADING DATA**

Use only laboratory tested reloading data. We highly recommend the current Speer® Reloading Manual.

 **OBSERVE ALL WARNINGS ABOUT THE USE OF MAXIMUM LISTED LOADS.**

### **WORKING WITH CARTRIDGE CASES**

- Examine empty cases to be sure they are in good condition before reloading. Thin, split, deformed, or badly corroded or pitted cases may be structurally weak, and result in a dangerous condition. Pay particular attention to splits in the mouth, separation between the case and the head, and dents in the shoulder.
- Do not store cartridge cases or ammunition near harsh chemicals such as gasoline, household cleaners or cat urine. The fumes can weaken the metal and present a dangerous condition.
- Do not clean cases with chemicals other than those specifically designed for the purpose.
- Do not attempt to clean loaded ammunition or primed cases. Doing so can cause corrosion, and weaken the case, or cause a misfire/hangfire condition.
- Ensure cases have proper primer pocket sizes; remove primer staking/crimp if necessary. Attempting to seat a primer into an undersized pocket or pocket with staking/crimping can result in detonation.
- Do not ream out or enlarge flash holes of cartridge cases. This may change the ignition rate and result in dangerous pressures.
- Resize and trim fired cases to ensure reliable chambering and obtain proper bullet tension and crimp.
- Never attempt to guess at the identity of your ammunition.

## MAIN FEATURES

- Magnetic damping
- Leveling foot for easy zero balancing of scale
- Rugged die-cast aluminum base
- Ambidextrous design
- Ambidextrous scale pan

The M500 has a 505-grain capacity, and features a two-poise system. Adjustments made using the main poise, on the left side of the beam, adjust from 5 to 500 grains, in 5-grain increments. The small poise on right side of beam adjusts from 0 to 5 grains, in 0.1 grain increments. The M500 utilizes magnetic damping to eliminate unnecessary beam oscillation. It features a rugged die-cast base with a large adjustable foot for extra stability on the bench. Self-aligning ceramic bearings support the hardened steel beam pivots to guarantee sensitivity to 0.1 grain. Ambidextrous design with dual graduation markings allows the user to read the weight readings from either side of the scale.

## UNPACKING

Your M500 scale is packed in a specially designed carton to provide maximum protection. Unpack the scale carefully to avoid damaging components. Identify parts as you carefully unpack (Photo 1).

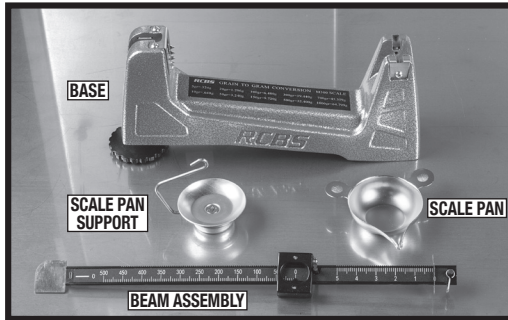

Photo 1: Scale Components

The M500 scale is a highly precise reloading instrument. We suggest using either OIML Class F2 standard check weights or NIST class F RCBS® Check Weights as standard check weights for checking the accuracy of your scale.

## ASSEMBLY

To assemble your M500 scale, place the beam assembly onto the base by first inserting the damping vane in between the zero reference pointers (Photo 2). Next rest the sharp edges of the pivot portion of the beam onto the ceramic bearings (Photo 3). Place pan support onto shackle located at the end of the beam (Photo 4). To complete assembly place scale pan onto pan support (photo 5).

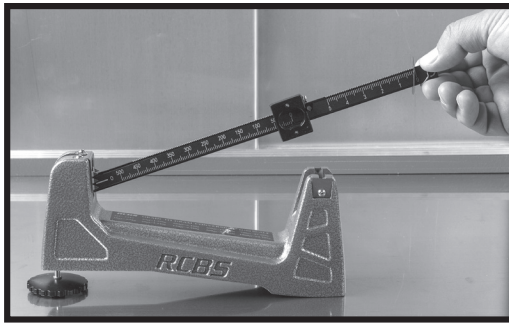

Photo 2: Beam placement

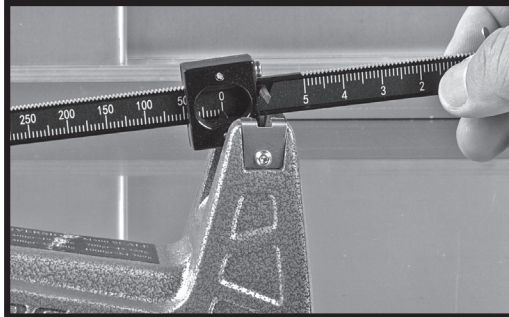

Photo 3: Placement of pivots onto ceramic bearings

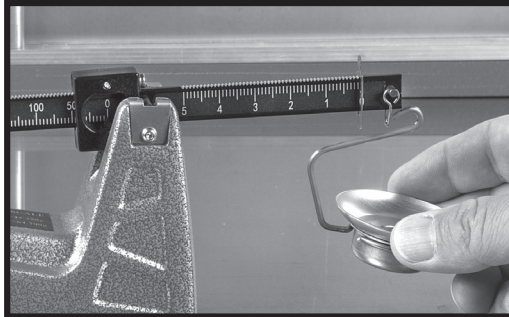

Photo 4: Place pan support onto shackle

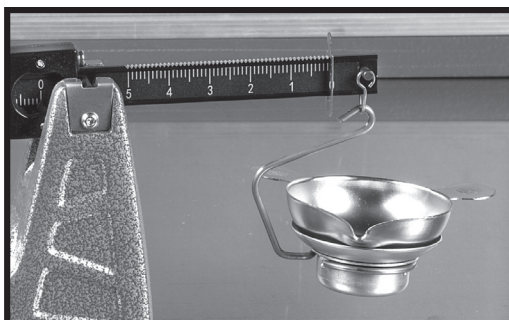

Photo 5: Place pan onto pan support

## AMBIDEXTROUS USE

The M500 scale is designed for use by both right- and left-handed users. The scale pan consists of two tabs, a main beam with graduation markings on both sides, and a set of reference pointers on each side. Photos 6 and 7 show the M500 with a 100-grain load in both a right- and left-handed orientation.

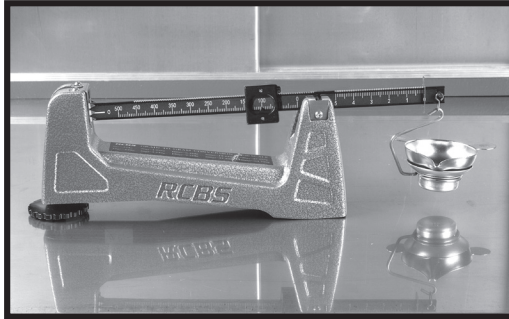

Photo 6: Right-handed operation using 100-grain weight

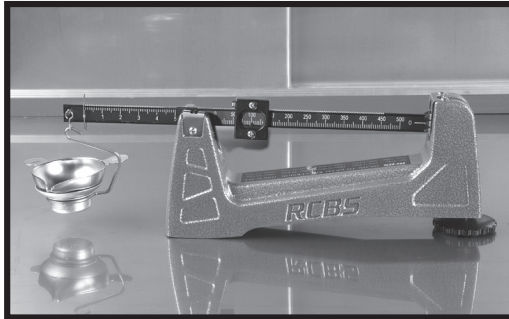

Photo 7: Left-handed operation using 100-grain weight

## HOW TO ZERO BALANCE THE SCALE

(directions below are for right-handed use)

- Place the scale on a flat, level surface
- Set in a location which allows viewing of scale as near to eye level as possible; this will eliminate any potential parallax error
- Place both poises at zero
- Place scale pan on pan support
- Scale is balanced when zero line on main beam lines up with center reference pointer (Photo 8)
- If zero line does not line up with center reference pointer, rotate leveling foot clockwise to move reference pointer upward, or rotate counter-clockwise to move reference pointer downward (Photo 9)
- The scale should be zero balanced before use and checked periodically during use for maximum accuracy and protection against error.

NOTE: DO NOT MOVE SCALE ONCE BALANCED. IF SCALE IS MOVED, FOLLOW STEPS ABOVE TO RE-ZERO SCALE.

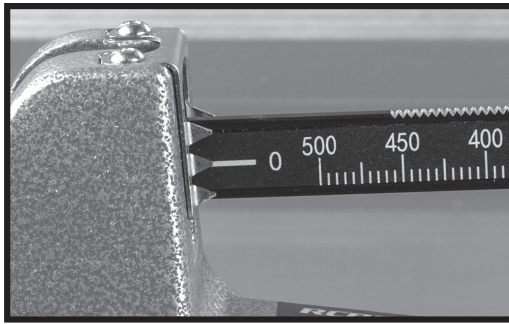

Photo 8: Scale balanced

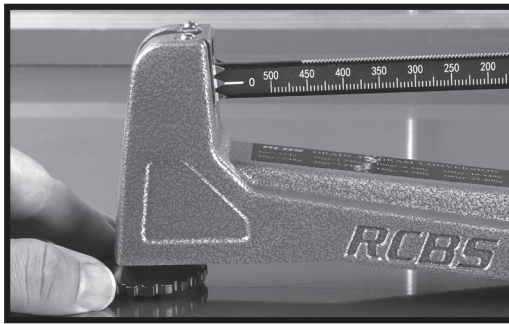

Photo 9: Rotating leveling foot to zero balance scale

## CALIBRATION

The pan support on the M500 scale is calibrated prior to packaging and there should be no difficulty in zero balancing your scale. However, if there is not enough adjustment in the leveling foot to zero balance your scale, it may be necessary to re-calibrate the pan support. To accomplish this, remove the pan support top from the weight holder, using a Phillips screwdriver (Photo 10). The weight holder contains several non-magnetic weights; if weight needs to be added to pan make sure to use only non-magnetic material. Magnetic weights might affect the scale's accuracy (Photo 11). Place all weights and pan support screw into scale pan (Photo 12). Place pan support back onto weight holder and re-attach pan support to shackle on beam. Place scale pan containing calibration weights and pan support screw onto pan support (Photo 13). Adjust leveling foot to its midpoint and add or remove weights to bring beam into balance (Photo 14). When zero balanced is achieved, as shown in Photo 8, place all calibration weight material into weight holder and secure pan support to weight holder (photos 15 and 16). The pan support is now re-calibrated and ready for use.

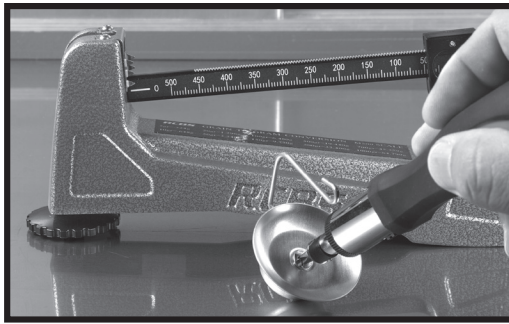

Photo 10: Removing pan support



Photo 11: Weight holder containing non-magnetic material

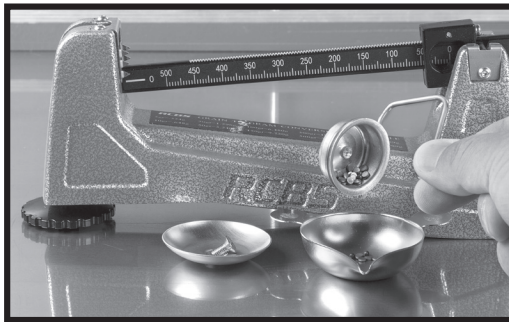

Photo 12: Place calibration weights into scale pan

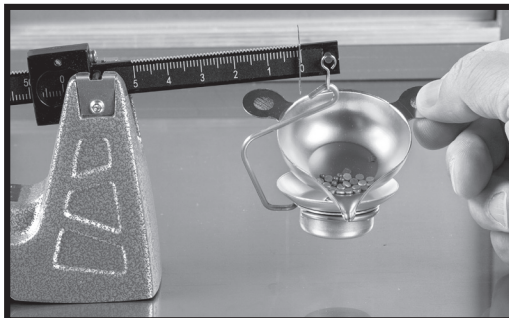

Photo 13: Place scale pan onto pan support





Photo 14: Add or remove calibration weights



Photo 15: Place calibration material back into weight holder

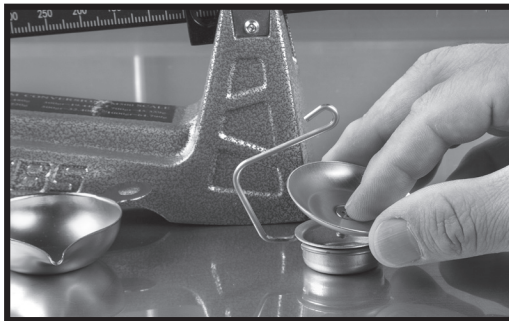

Photo 16: Secure pan support to weight holder

### HOW TO USE THE MAIN POISE (500 GRAIN)

The main poise consists of an accurately adjusted weight that moves parallel to the axis of the beam. It is positioned at weight values by means of a pawl that engages notches in the beam. The poise run is from 0 to 500 grains, with equally-spaced notches that divide this distance into 100 equal parts. Each subdivision is equivalent to 5 grains of weight.

To zero the main poise, move it to the position where the pawl, located on the right side of the poise, engages the first notch on the right end of the poise travel. The poise indicator will line up with the "0" graduation (Photo 17).

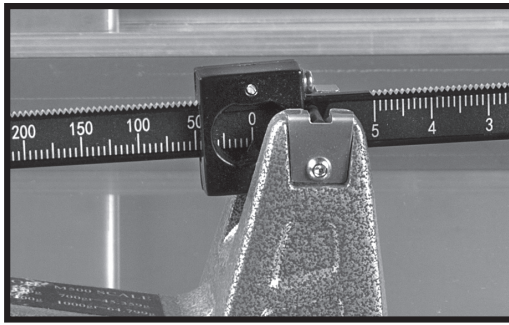

Photo 17: Main poise set on zero

To increase weight values, move the poise to the left and line up the indicator with the desired graduation. **Always make sure the pawl is seated in the notch.** Correct setting for 160 grains (Photo 18).

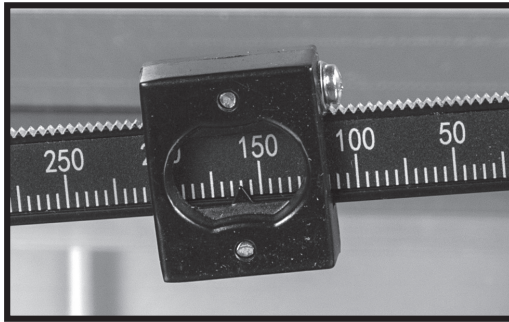

Photo 18: Main poise set at 160 grains

Do not attempt to set the main poise at any position except firmly seated in a notch. Always use the small poise for weight values between the 5-grain increments of the large poise.

### HOW TO USE THE SMALL POISE (5 GRAIN)

The small poise functions the same as the large poise. This poise run is from 0 to 5 grains and the equally spaced notches divide this distance into 50 equal parts; each subdivision is equivalent to 1/10 (0.1) grain of weight.

To zero the small poise, move it to the position where the pawl, which is the top edge of the rectangular slot through the poise, engages the notch directly above the "0" graduation. The long, vertical edge of the poise is the indicator and will line up with the "0" graduation.

To increase weight values, move the poise to the left and line it up with the desired graduation. **Always make sure the pawl is seated in the notch.** Correct setting for 3.7 grains (Photo 19).

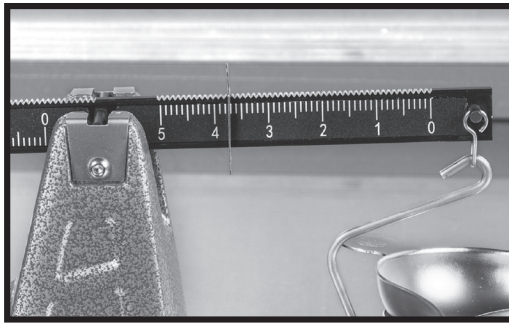

Photo 19: Small poise set at 3.7 grains

Do not attempt to set the poise at any position; only set in a position where it is firmly seated in a notch.

### HOW TO USE THE POINTERS

The pointer contains three separate pointers for easy reading of over and under loads. The center pointer is what is used when balancing the scale and establishes a ZERO Balance. The top and bottom pointers represent approximately 0.5 to 0.7 grain above and below target load. The top and bottom pointers allow the user to quickly weigh loads knowing that if the beam pointer is oscillating between the top and bottom pointers the load is within +/- 0.5 to 0.7 grains. Having top and bottom pointers also eliminates the need to move the small poise to check powder charge variations. NOTE: WHEN SCALE IS ZERO BALANCED IT IS GOOD PRACTICE TO VERIFY THE EXACT LOAD REQUIRED FOR THE BEAM POINTER TO REACH THE TOP AND BOTTOM POINTERS.

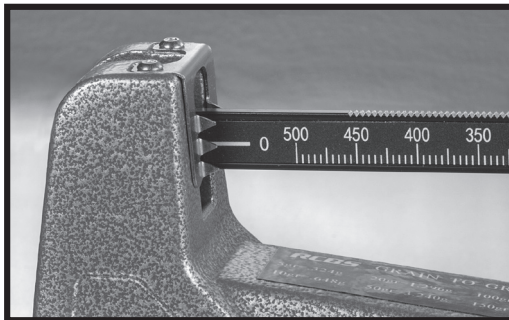

Photo 20: Center pointer at 0.1 grain above reference target load

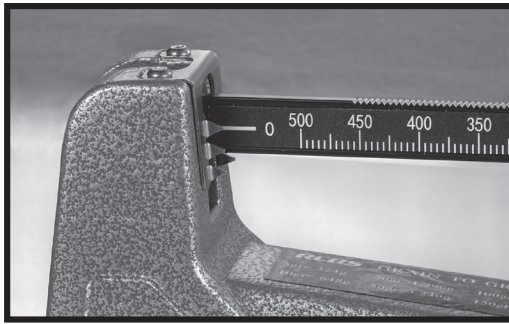

Photo 21: Top pointer at 0.5 grains above reference target load

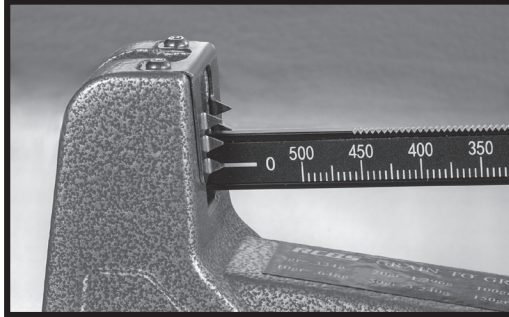

Photo 22: Bottom pointer at 0.5 grains below reference target load

### **MAGNETIC DAMPING**

The M500 scale is equipped with magnetic damping which causes the beam to come to rest quickly without affecting sensitivity or accuracy. It operates on the principle of a permanent magnetic field resisting the motion of a non-magnetic copper damper vane attached to the beam.

The damping magnets are positioned inside the base on both sides of the slot in which the damper vane travels.

The only maintenance required is to keep this slot free of magnetic particles which could interfere with free movement of the damper vane. The magnetic damping is effective at all loads and will speed up weighing.

### **HOW TO WEIGH**

To weigh an unknown load, place the load in the scale pan. Move the main poise to the first notch, which causes the beam pointer to drop below the center reference pointer, and then move it back one notch. Then move the small poise to the notch to bring the beam pointer to the center reference pointer. The weight of the unknown load is the sum of the two poise readings (Photo 23).

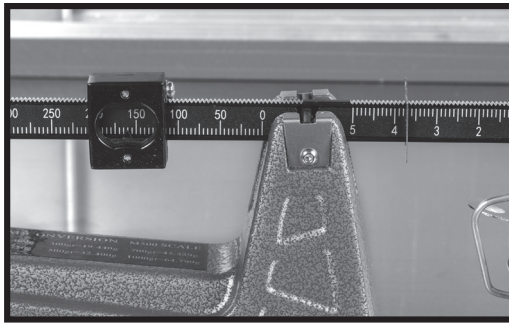

Photo 23: Scale reading of 163.7 grains

The scale can also be used to weigh out predetermined powder charges; either alone or in combination with a powder measure set to throw a light charge.

In either case, the desired final weight of the charge is preset on the poises. This will cause the beam pointer to fall below the center reference pointer. Add powder to the pan until the beam balances. For efficient and effective results, we recommend using an RCBS® Powder Trickler-2 (sold separately).

When making repeated weighings in this manner, avoid errors by making sure the poises remain in their correct positions and are not accidentally moved.

#### **HOW TO CARE FOR YOUR SCALE**

Keep the scale clean at all times and be particularly careful to prevent the accumulation of dirt on the pivots and bearings. NOTE: NEVER APPLY OIL OR ANY LUBRICANT TO THE PIVOTS OR BEARINGS, AS THIS CAN LOWER THE ACCURACY AND REPEATABILITY OF THE SCALE.

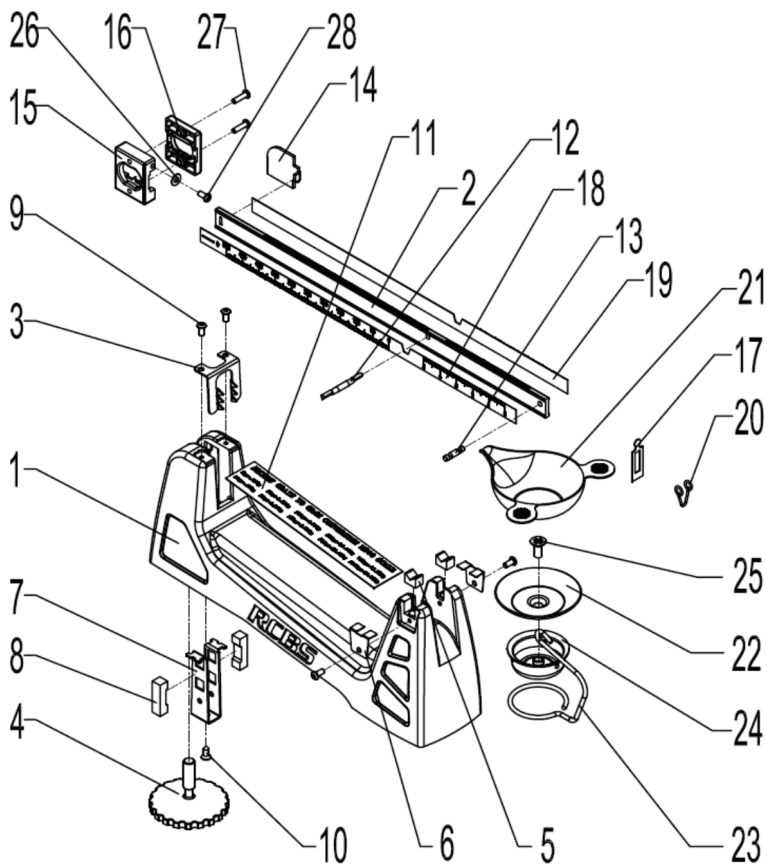

ITEM	DESCRIPTION	QTY
1	Base	1
2	Beam	1
3	Pointer	1
4	Leveling Foot	1
5	Ceramic Bearing	2
6	Bearing Retainer	2
7	Magnet Fixing	1
8	Magnets	2
9	Screws (M3x6)	4
10	Screws (ST2.9x8)	1
11	Conversion Label	1
12	Center Pivot	1
13	Front Pivot	1
14	Damping Vane	1

ITEM	DESCRIPTION	QTY
15	Main Poise (Front)	1
16	Main Poise (Back)	1
17	Small Poise	1
18	Graduation Mark (Front)	1
19	Graduation Mark (Rear)	1
20	S/S Shackle	1
21	Scale Pan	1
22	Pan Support (Top)	1
23	S/S Hook	1
24	Weight Holder	1
25	Screws (M5x10)	1
26	Washer	1
27	Screws (M3x10)	2
28	Screws (M3x6)	1

## **RCBS LIMITED WARRANTY**

Your RCBS® M500 Mechanical Scale is warranted to be free from defects in material or workmanship for as long as the original owner owns it. This warranty is extended only to the original consumer purchaser. All RCBS products are intended for non-commercial use by hobbyists. Any other use of these products will void the warranty. If you believe that your product is covered by this warranty, you must return the product to RCBS at the address below, postage paid, with proof of purchase for evaluation. If covered, we will (at our sole option) repair, replace or refund the purchase price of any part or product found to be defective. This remedy will be without charge except for reasonable shipping, handling and insurance charges.

TO ENSURE ACCURACY OF YOUR WARRANTY INFORMATION, SEND YOUR DATED PROOF OF PURCHASE TO THE ADDRESS BELOW. This limited warranty does not cover defects or damage resulting from carelessness, misuse, commercial use, abuse, neglect, improper installation or assembly, water submersion, unauthorized or improper repair, failure to follow operation instructions, modification or normal wear and tear.

ANY WARRANTIES IMPLIED BY LAW SHALL IN NO EVENT EXTEND BEYOND DURATION OF THIS EXPRESS WARRANTY. Some states do not allow limitations on how long an implied warranty lasts, so the above limitation may not apply to you. REPAIR OR REPLACEMENT AS PROVIDED HEREIN IS YOUR EXCLUSIVE REMEDY FOR ANY DEFECTIVE PRODUCT. IN NO EVENT SHALL WE BE LIABLE FOR ANY SPECIAL, INCIDENTAL, OR CONSEQUENTIAL DAMAGES OF ANY KIND ARISING OUT OF THE PURCHASE OR USE OF THIS PRODUCT, WHETHER BASED UPON CONTRACT, TORT, STATUTE OR OTHERWISE. Some states do not allow the exclusion or limitation of incidental or consequential damages, so the above limitation or exclusion may not apply to you. This warranty gives you specific legal rights, and you may also have other rights which vary from state to state.

## **CONTACT US**

RCBS • 605 Oro Dam Blvd East

Oroville, CA, 95965

1-800-379-1732 (U.S. or Canada)

E-mail: [rcbs.tech@vistaoutdoor.com](mailto:rcbs.tech@vistaoutdoor.com)

Website: [rcbs.com](http://rcbs.com)



**PRECISIONEERED RELOADING EQUIPMENT**

We think we make the world's best reloading equipment.  
If you agree, please tell your friends. If you disagree,  
tell us—we want to do something about it!

Customer Service

1-800-379-1732 (U.S. or Canada)

Hours: Monday - Friday, 5:00 a.m. – 5:00 p.m. Pacific Time

(hours may vary)

E-mail [rcbs.tech@vistaoutdoor.com](mailto:rcbs.tech@vistaoutdoor.com), or visit [rcbs.com](http://rcbs.com)

RCBS • 605 Oro Dam Blvd. East • Oroville, CA 95965