

**RCBS**

**Model 10-10<sup>®</sup> Scale  
Instructions**

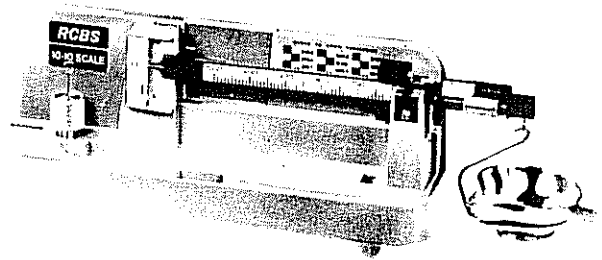

**IMPORTANT**

Since the powder charge is the most critical portion of a reloaded cartridge, it is very important that you take a few minutes to read these instructions carefully to gain an understanding of the use of the micrometer poise before attempting to weigh powder charges.

## About your RCBS Model 10•10 Scale

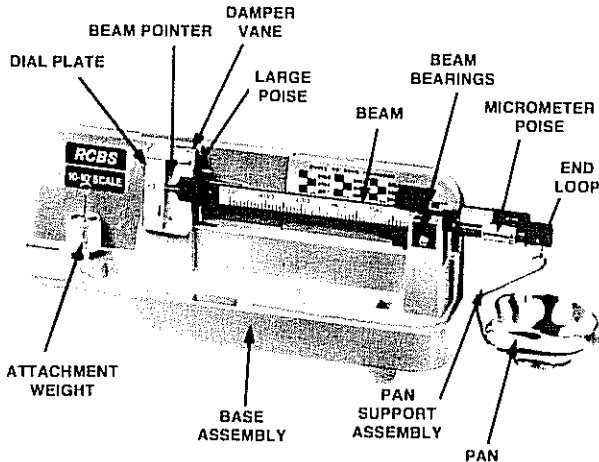

The Model 10•10 has a capacity of 510 grains. Capacity can be increased to 1,010 grains, without losing sensitivity, merely by adding the attachment weight.

In addition, this scale has all the features of the RCBS Model 5•10 Scale. (1) Micrometer Poise for weighing speed and accuracy, (2) Special approach-to-weight system, (3) Large easy-to-read graduations, (4) Magnetic Damper, (5) Guaranteed 1/10th of a grain sensitivity, (6) Agate Bearings, (7) Anti-tip pan design.

When your Model 10•10 is not in use, you can store components in the die cast base. A moulded dustproof cover (not shown) snaps into place to protect your scale.

*This scale is manufactured exclusively for RCBS by Ohaus Corporation*

*19A Chapin Road  
P.O. Box 2033  
Pine Brook, NJ 07058-2033  
Telephone 973 377-9000*

10 • 10 is a registered trademark of Ohaus Corporation.

## RCBS RELOADING ACCESSORIES AVAILABLE AT YOUR GUN DEALERS

### RCBS Powder Trickler



Here's the fast, easy way to balance scales when weighing precision powder charges: merely twist the Trickler Knob and powder will trickle into Scale Pan, a kernel at a time. To use with Powder Measure: set measure short of desired charge — dump charge into Scale Pan and balance Scale with Trickler. Has large capacity powder reservoir — extra-large base to minimize tipping. Ideal height for all powder scales.



### Send for Free Catalog

Loaded with photos and drawings. Shows complete line of famous RCBS reloading tools and prices; lists reloading dies for over 200 calibers, reference tables, and a heap of other interesting information. Most informative and most descriptive reloading catalog available anywhere.

### RCBS Powder Funnel

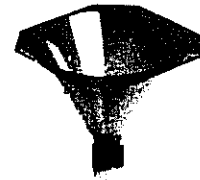

For powder charging just a few cases at a time! Large, easy-to-use, plastic Powder Funnel in two sizes: .22 to .45 calibers and .17 caliber. Specially designed drop tube prevents powder spills around case mouths. Anti-static treatment prevents powder from sticking. Square lip stops Funnel from rolling.

### HOW TO USE THE LARGE POISE (500 GRAIN)

The principle of the large poise consists of an accurately adjusted weight which moves parallel to the longitudinal axis of the beam and which is positioned at weight values by means of a pawl engaging notches in the beam. The poise run is from 0 to 500 grains. The equally spaced notches divide this distance into 50 equal parts so that each subdivision is equivalent to 10 grains of weight.

To zero the large poise, move it to the position where the pawl, located on the right side of the poise, engages the first notch on the right end of the poise travel. The poise indicator will line up with the zero graduation.

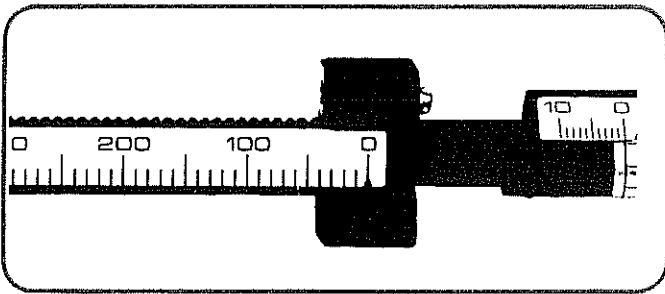

To increase weight values, move the poise to the left and line up the indicator with the desired graduation. **Always make sure that the pawl is seated in the notch.**

Illustrated is a setting of 160 grains.

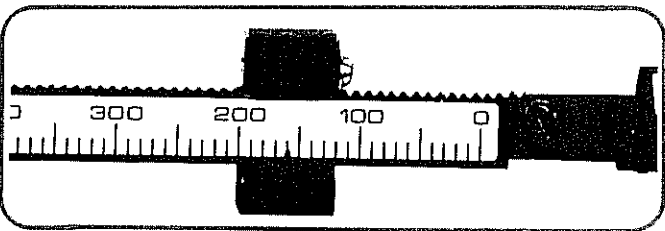

**Do not attempt to set the large poise at any position except firmly seated in a notch.** Always use the micrometer poise for weight values between the 10 grain increments of the large poise.

### HOW TO USE THE MICROMETER POISE (10 GRAIN)

The principle of the micrometer poise consists of an internally threaded weight, also accurately adjusted, which rotates on a fixed screw or spindle. The pitch of the screw thread is  $\frac{1}{24}$ " , or 24 threads per inch, and exactly matches the spacing of graduations on the 0-10 grain scale. Therefore, one complete revolution (360°) of the poise around the spindle will move the poise longitudinally a distance equivalent to 1 grain of weight (10 revolutions for 10 grains).

The cylindrical surface of the micrometer poise is subdivided into 10 equal parts by means of the long horizontal lines which are numbered from 0-9. Rotating the poise from one of these lines to the next moves the poise longitudinally  $\frac{1}{10}$ th the distance of a complete revolution or a distance equivalent to  $\frac{1}{10}$ th grain of weight.

A nylon screw coming in from the back of the beam is used to lock the micrometer poise in place to prevent movement during weighing. Only light finger pressure is required to tighten or loosen this screw.

To zero the micrometer poise, line up the radial indicator line near the left end of poise with the zero graduation on the 0-10 grain scale and line up the zero line on the surface of the poise with the reading edge of 0-10 grain scale.

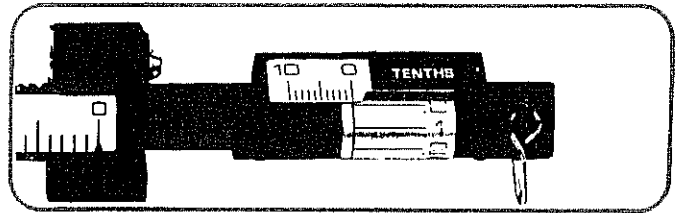

To increase weight values, rotate the front surface of the poise upward with your thumb, which will cause the poise to travel to the left. The indicator line near the left end of the poise will indicate grain values while the horizontal lines on the poise will indicate tenths of a grain.

Illustrated is a setting of a 3.7 grains.

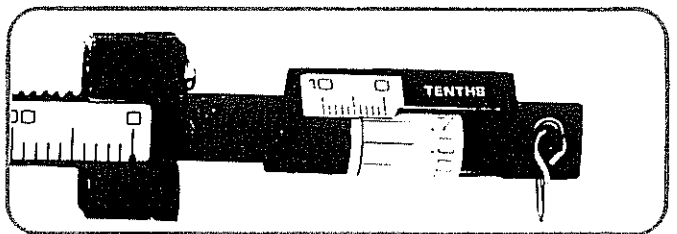

Notice that the indicator line is between the 3 grain graduation and the 4 grain graduation, indicating more than 3 grains but less than 4 grains, and the .7 grain horizontal line is lined up with the reading edge of the scale.

**Do not attempt to use the micrometer poise with the indicator line outside the limits of 0-10 grain graduated scale.** Weighing errors may result.

#### HOW TO ZERO BALANCE THE SCALE

Place both the large poise and the micrometer poise at zero. If the scale has been placed on a reasonably level surface, the beam pointer will come to rest fairly close to the zero graduation on the dial plate. Raise or lower the left end of the base by means of the leveling foot to line them up.

The scale should be zero balanced before use and checked periodically during use for maximum accuracy and protection against error.

#### MAGNETIC DAMPING

Your "10 · 10" Reloading Scale is equipped with magnetic damping which causes the beam to come to rest quickly without affecting sensitivity or accuracy. It operates on the principle of a permanent magnetic field resisting the motion of a non-magnetic, copper damper vane attached to the beam.

The pole faces of the damping magnets are positioned on both sides of the 1/4" wide slot that the damper vane travels in when the beam is in place.

The only maintenance required is to keep these magnets free of magnetic particles which could interfere with free movement of the damper vane.

The magnetic damping is effective at all loads and will speed up weighing.

#### HOW TO WEIGH

To weigh an unknown, such as the throw of charge from a powder measure, place it in the scale pan. Move the large poise to the first notch which causes the beam pointer to drop below zero and then move it back one notch. Next, rotate the micrometer poise to the position which brings the beam pointer to zero. The weight of the unknown is the sum of the two poise readings.

Note: Read the micrometer poise to the nearest .1 grain.

Illustrated is a total weight of 163.7 grains.

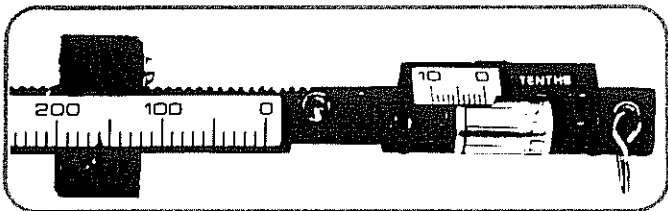

For weighings over 500 grains, suspend the 500 grain attachment weight, stored in the leveling screw, from the knife edge of the pivot which protrudes from the pointer end of the beam. Proceed to weigh as before, using the poises, and add 500 grains to the sum of the poise readings.

#### APPROACH-TO-WEIGHT FEATURE

Your "10 · 10" Reloading Scale incorporates a unique approach-to-weight feature developed by Ohaus Corporation. This feature allows you to pour powder quickly without overshooting the weight wanted. It is useful to the reloader who either weighs out each powder charge on his scale or who uses the scale to weigh charges dispensed from a powder measure. In either case you pre-set the powder weight wanted on the poises. This will bring the beam pointer below the zero mark.

As the powder poured into the scale pan begins to approach the pre-set weight, the beam pointer will move slowly upward past the arrowhead on the dial plate. This visually tells you that very little more powder is needed to balance the scale.

The visible indication of approach to a balanced condition allows for rapid pouring of powder until close to balance and then slower pouring to a final zero balance. This feature prevents annoying overshooting and the need to remove powder from the pan.

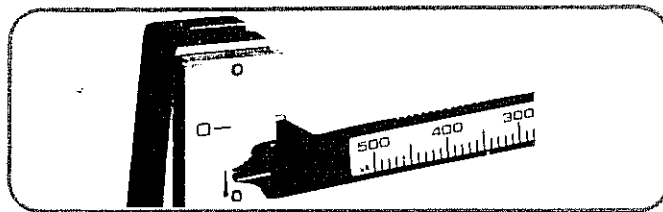

When making repeated weighings in this manner, avoid weighing errors by making sure that the poises remain in their correct positions and are not accidentally moved.

The approach-to-weight leaf spring has been adjusted at the factory, by means of the hex socket set screw accessible from the top surface of the base, so that in its free position it just touches the underneath side of the base near the damper vane slot without exerting any upward force. It should rarely require any adjustment by the user.

#### HOW TO CARE FOR YOUR SCALE

Your "10 · 10" Reloading Scale should be stored in its case when not in use. This offers the greatest protection against accidental damage and dirt. To ensure that the attachment weight does not fall out of its storage well if the balance is moved, the leveling screw should be in its highest position before putting the cover in place.

Keep the scale clean at all times and be particularly careful to prevent the accumulation of dirt on the pivots and bearings. **Never** apply oil or any lubricant to the pivots or bearings; this will lower the accuracy of the scale.

The scale cover is made of high impact thermoplastic and should last for the life of the scale. However, keep away from high temperatures.

## UNPACKING AND SETUP

Remove the scale from the carton and discard the outer plastic wrapper. Turn the scale upside down. Using a wrench or pliers, loosen the large acorn nut at the left end. This will free the leveling foot.

Place the scale on a reasonably flat and level surface. To remove the cover, apply thumb pressure at the depression in the front-center of the cover and lift off. Note that your "10•10" is designed to self-store all its parts. As you remove parts, notice how they store so you can return them to these positions.

Remove the pan support and pan and set to one side. Remove the beam from its storage position and discard the inner plastic wrapper. Insert the beam in its bearings, making sure to position the copper damper vane in the slot at the left end of the base. Hang the pan support and pan from the end loop.

Note the way the pan support cradles the pan. This feature makes it possible to weigh long, heavy objects such as cases and loaded cartridges without tipping the pan off its support. The pan support may also be rotated within the wire hanger for a more convenient handle position.

Your "10•10" is now ready for use.

## CAUTION!

The end loop **MUST** not be bent or twisted when unpacking.

For your 10•10 scale to operate properly:

- Both sides of the end loop **MUST** be parallel to the beam.
- The end loop shall move freely in the pivot notches and hang in a position perpendicular to the knife edges.

