

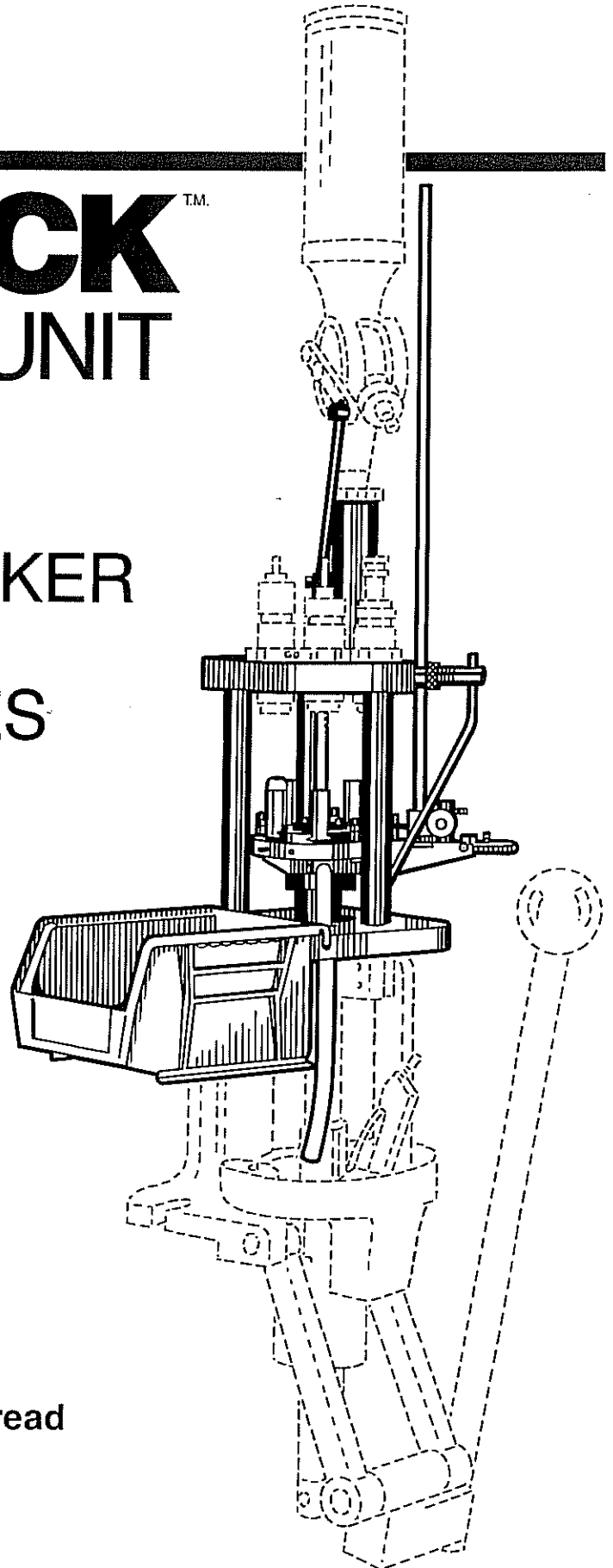

PIGGYBACKTM CONVERSION UNIT

FOR USE WITH
RCBS ROCK CHUCKER
AND RELOADER
SPECIAL-3 PRESSES



⚠ WARNING:

Do not attempt to assemble, install
or operate this unit until you have read
this safety and operating manual.

IMPORTANT

Before attempting to assemble the RCBS Piggy-back **READ THIS MANUAL CAREFULLY** to learn how to safely operate the tool. Failure to properly operate this product can result in severe personal injury and/or equipment damage.

This manual contains specific safety and operating information. It should be considered a permanent part of your reloading tool and, for easy reference, remain with the equipment at all times. If you have any questions at any time while assembling or operating this tool, call us by using the phone numbers printed on the back of this safety and instruction manual.

SAFETY MESSAGE SIGNAL WORDS

This safety symbol, , is used throughout the instruction manual for important safety messages. When you see this symbol, follow the important safety messages to avoid severe personal injury and/or equipment damage.

 **WARNING:** This means severe personal injury, death or property damage can occur if the message is ignored.

 **CAUTION:** This means that minor personal injury or property damage can occur if the message is ignored.

NOTE: This signal word is used to give you helpful installation, operation or maintenance information.

In addition to the safety and operating instructions there is a **HELPFUL HINTS** section included on pages 24 & 25.

SAFETY

Reloading is an enjoyable and rewarding hobby that is easily conducted with safety. But carelessness or negligence can make reloading hazardous. This product has been designed from the beginning with the user's safety in mind.

As with any reloading operation, some safety rules must be followed. By observing these few rules, the chance of a hazardous occurrence causing damage or injury becomes extremely remote.

GENERAL

- Use the reloading equipment as the manufacturer recommends. Study the instructions carefully and

become thoroughly familiar with the operation of the product. Don't take short cuts.

- Observe "good housekeeping" in the reloading area. Keep tools and components neat, clean and orderly. Promptly and completely clean up primer and powder spills.
- Reload only when you can give your undivided attention. Do not reload when fatigued or ill. Develop a reloading routine to avoid mistakes. Avoid haste - load at a leisurely pace.
- Always wear adequate eye protection. You assume unnecessary risk when reloading without wearing safety glasses.

LOADING DATA

- Use only laboratory tested reloading data. We highly recommend the use of the SPEER Reloading Manual.
- **OBSERVE ALL WARNINGS ABOUT THE USE OF MAXIMUM LISTED LOADS.**

PRIMERS AND POWDER

- **WARNING:** Primers are designed to explode and will do so when subjected to heat, impact or static electricity.
- Do not decap live primers.
- Never attempt to seat or reseal a primer in a loaded round.
- Store primers and powder beyond the reach of children and away from heat, dampness, open flames and electrical equipment.
- **DO NOT** use primers of unknown identity. To destroy unwanted primers, soak in oil for a few days.
- Keep primers in original factory container until ready to use. Return unused primers to the same factory packaging for safety and to preserve their identity.
- **DO NOT** store primers in bulk. The blast of just a few hundred primers is sufficient to cause serious injury to anyone nearby.
- **DO NOT** force primers. Use care in handling primers.
- **DO NOT** use any powder unless its identity is positively known. Discard all mixed powders and those of uncertain or unknown identity.
- If you use a powder measure, replace the lids on both the powder hopper and powder can after the powder hopper has been filled.
- Before charging cases, settle the powder in the powder hopper. Throw and check the weight of at least ten charges. This will assure that the correct powder charge is being thrown.
- After a reloading session ends, pour the remaining powder back in its original factory container. This will preserve the identity and shelf life of the powder.
- **DO NOT** smoke while handling powder or primers.

RECORD KEEPING

- Keep complete records of reloads. Apply a descriptive label to each box showing the date produced, and the primer, powder and bullet used. Labels for this purpose are packed with SPEER bullets.

Since RCBS has no control over the choice of components, the manner in which they are assembled, the use of this product or the guns in which the resulting ammunition may be used, no responsibility either expressed or implied, is assumed for the use of ammunition reloaded with this product.

GENERAL INFORMATION

The RCBS Piggyback Conversion Unit allows handloaders to utilize their single stage presses for automatic progressive reloading. The Piggyback features automatic indexing, priming, powder charging and loaded round ejection. A five-station shell plate (numbered the same as standard RCBS shell holders), reloading dies and the RCBS Uniflow™ Powder Measure are not provided with the Piggyback and must be purchased separately. Because Piggyback takes standard 7/8 x 14 reloading dies you can use that "favorite set" of dies or switch calibers quickly.

These instructions are intended for mounting the Piggyback on the RCBS Rock Chucker and Reloader Special-3 presses.

UNPACKING

Refer to the parts list on pages 28 & 29 for the proper identification of parts. There are four bags, numbered 1 through 4, containing small parts that are required to complete the assembly of the Piggyback. We suggest opening only the bag that is required as you assemble the Piggyback according to the following instructions.

Remember, if you need additional help or replacement parts, call RCBS. Refer to our phone numbers printed on the back of this manual.

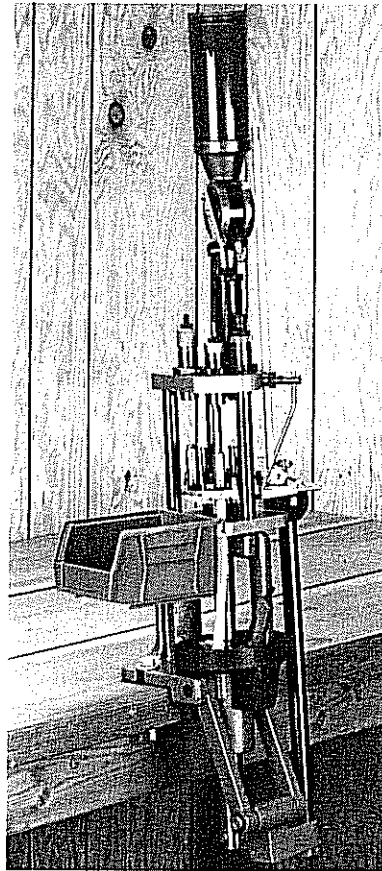

Piggyback mounted to a Rock Chucker Press.

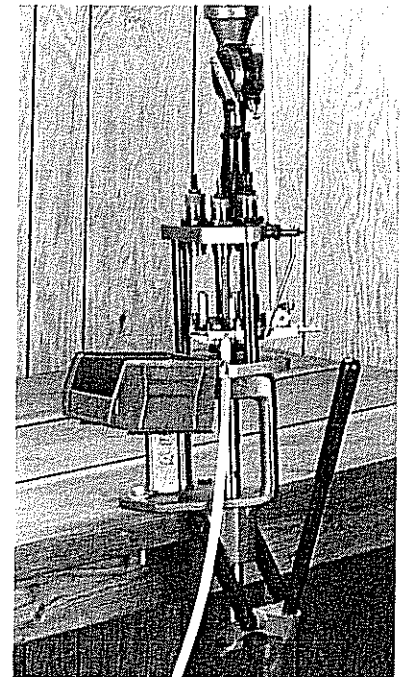

Piggyback mounted to a Reloader Special-3 Press.

ASSEMBLY AND INSTALLATION

You will need the following tools for easier assembly and installation of the Piggyback:

- 15" adjustable wrench or 1½" socket
- Small slotted blade screwdriver
- Long-nose pliers
- Small hammer
- Water pump pliers

Be sure your Rock Chucker or Reloader Special-3 Press is securely mounted to a sturdy bench. If an Automatic Primer Feed was previously installed on the Rock Chucker, it must be removed before proceeding.

STEP 1

The first step in assembling and installing your Piggyback is removing the existing bushing from the top of your reloading press. The 15" adjustable wrench (or 1½" socket) is required for this step. See Photos #1 & 2. The bushing in many older presses is extremely tight. If you have trouble removing the bushing, seek the help of a gunsmith or mechanic.

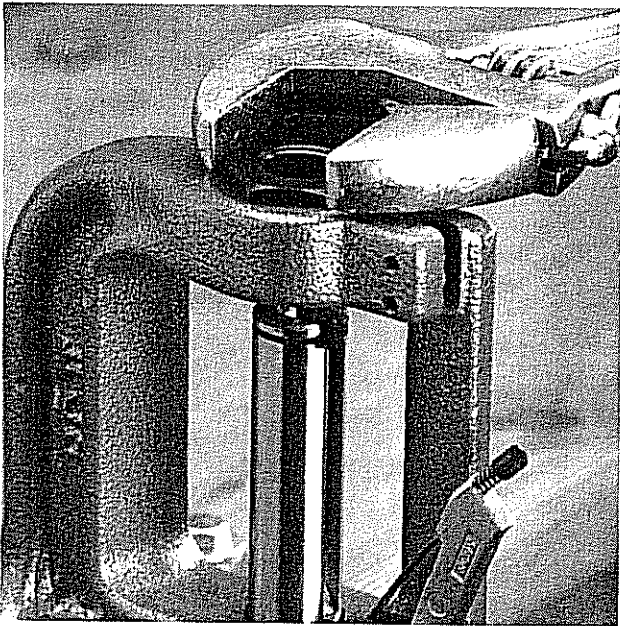

Photo #1: Remove the bushing from the press with a 15" adjustable wrench.

STEP 2

Open Bag #1 and check the parts against the drawing on the facing page. All the parts necessary for mounting the Piggyback to the press are in Bag #1. Also included in Bag #1 are the allen wrenches necessary for certain adjustments, and three die lock rings which will be discussed in a later section.

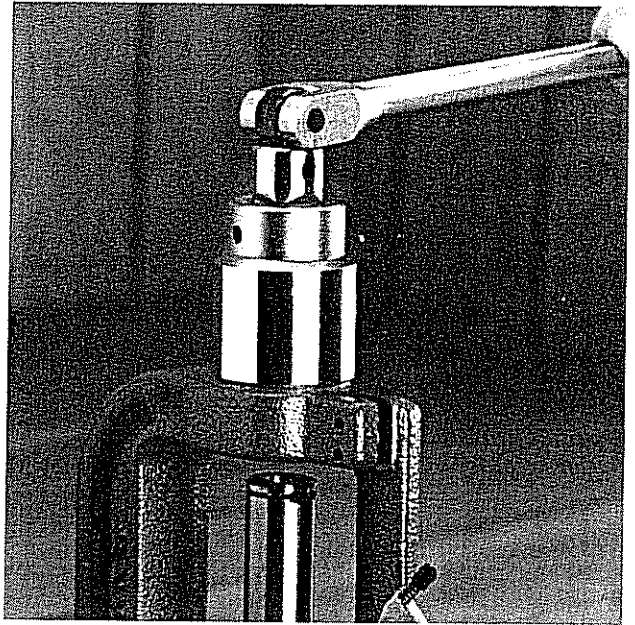

Photo #2: A 1½" socket can also be used to remove the bushing.

STEP 3

The locating pin is used with the Rock Chucker Press only. Install the knurled end of the locating pin in the smooth hole (not the threaded hole) in the bottom side of the bottom plate of the Piggyback. Tap about ½ the length of the pin into the hole until it is flush with the top side of the bottom plate. See Photo #3.

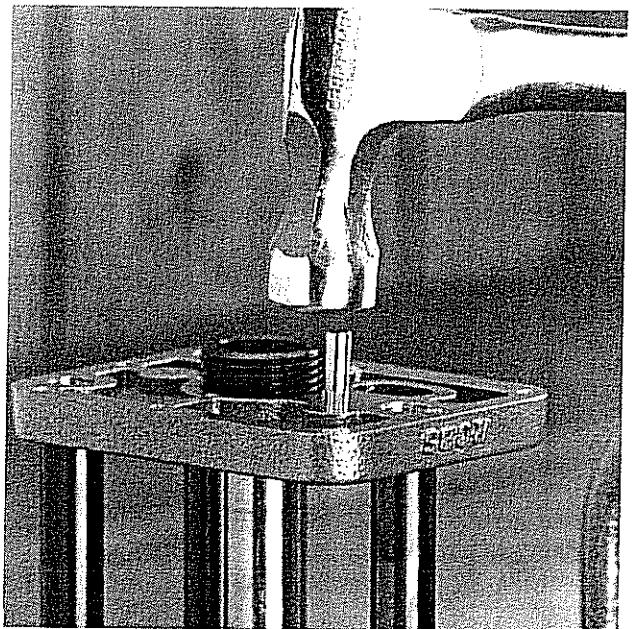
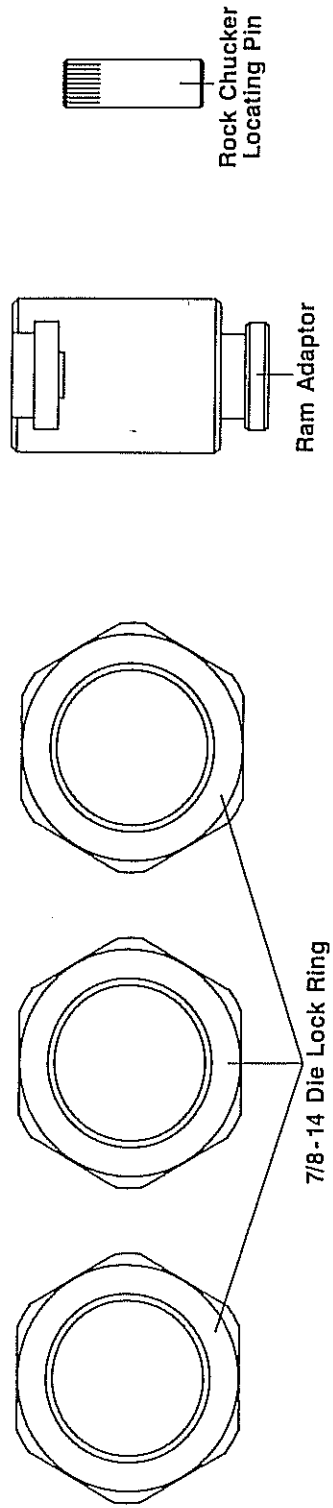
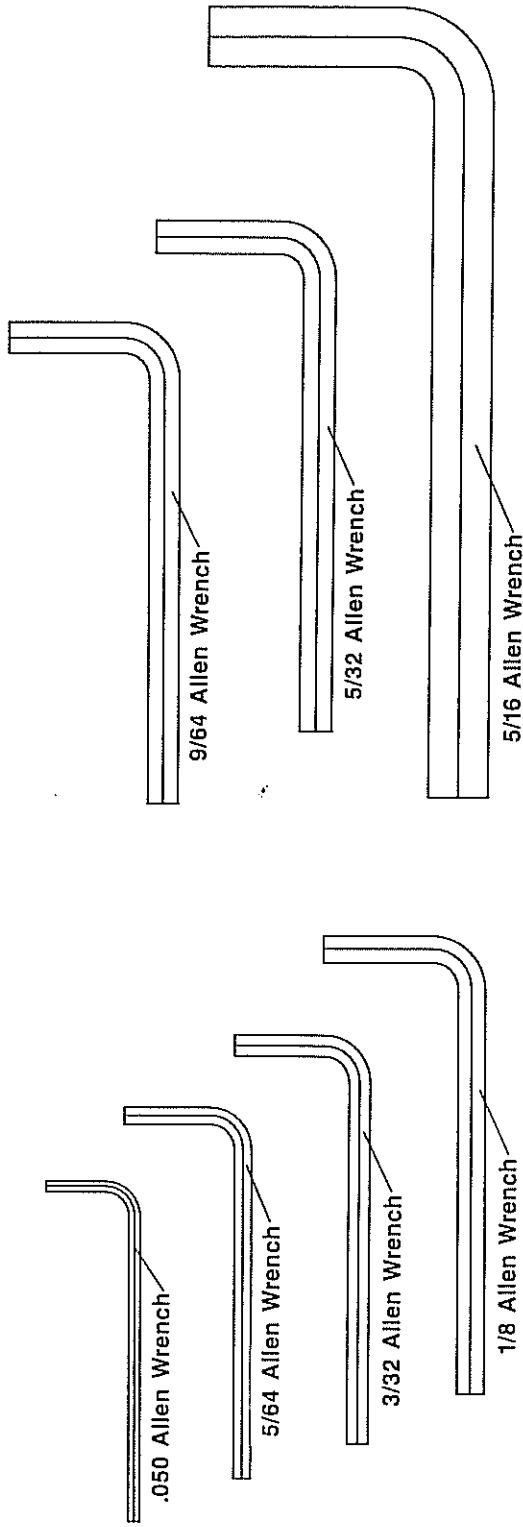

Photo #3: Tap the locating pin into the bottom side of the bottom plate. The locating pin will help orient the Piggyback on a Rock Chucker Press.

PARTS FROM BAG #1
(shown actual size)



STEP 4

For easier installation and removal, lightly lubricate (with gun oil) the large lock nut on the Piggyback.

Place the Piggyback on top of the press. The locating pin should slide into the milled slot that is normally used for the Automatic Primer Feed on the Rock Chucker Press. If the Piggyback is being installed on the Reloader Special-3, be sure the hole for the locating pin is facing toward the front of the press.

Guide the lock nut into the bushing hole on top of the press and finger-tighten the lock nut down. See

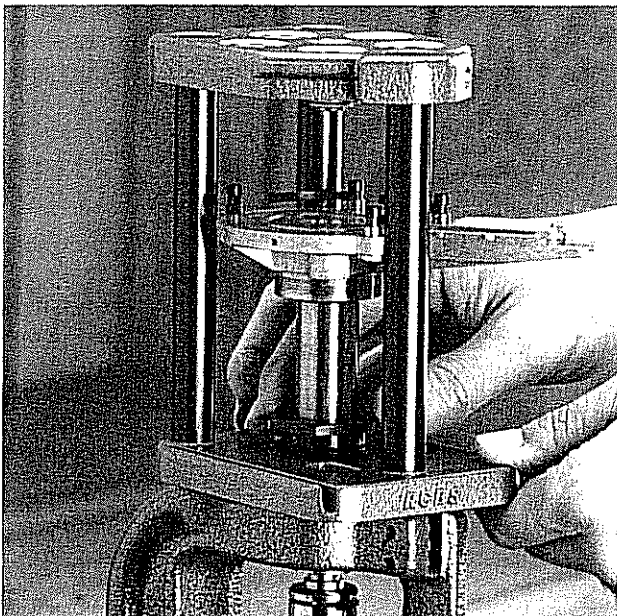

Photo #4: Guide the lock nut into the bushing hole.

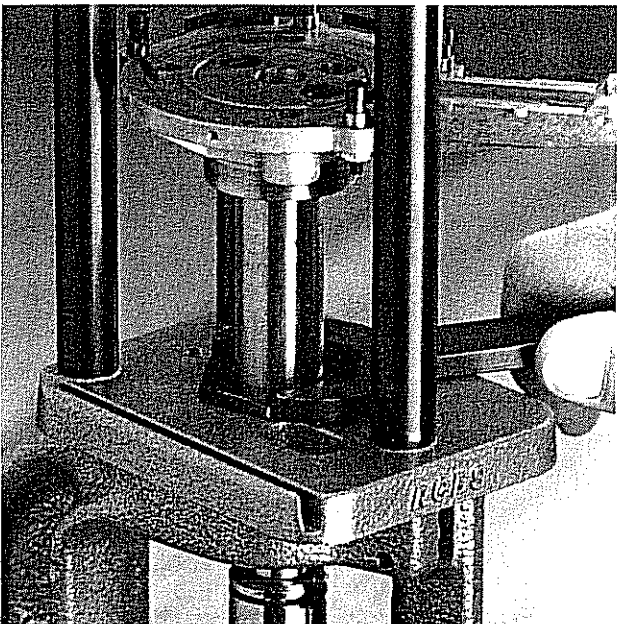

Photo #5: Securely tighten the lock nut into the bushing hole in the press.

Photo #4. Use a wrench or water pump pliers to securely tighten the lock nut.

STEP 5

Mate the ram adaptor with the press ram and the Piggyback ram at the same time. The ram adaptor slides in like a shell holder. Rotate the adaptor about $\frac{1}{2}$ of a turn to keep it from slipping loose. See Photo #6.

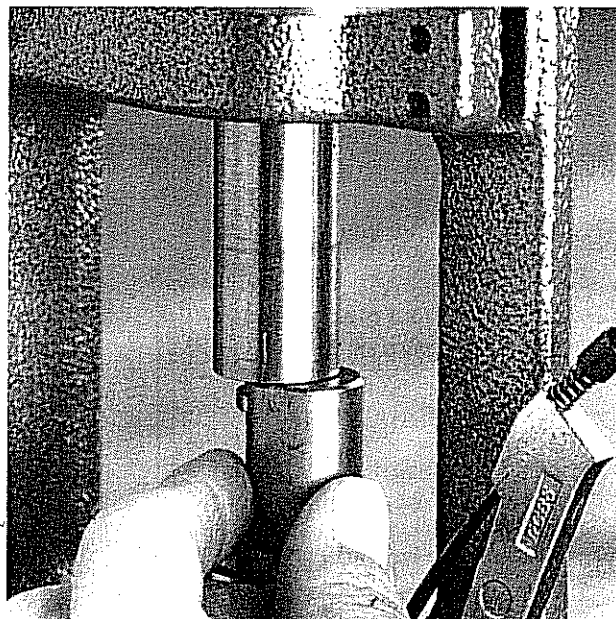

Photo #6: Install the ram adaptor.

⚠ CAUTION: FAILING TO ROTATE THE ADAPTOR CAN CAUSE THE ADAPTOR TO WORK LOOSE UNDER PRESSURE THEREBY DAMAGING THE PRESS AND/OR CONVERSION UNIT.

INDEXING SYSTEM AND SHELL PLATE INSTALLATION

The Piggyback uses a five-station shell plate that has the same numbering system as RCBS shell holders. Shell plates are available for a variety of popular calibers. Consult the chart below for the proper shell plate number and primer size.

PIGGYBACK REFERENCE TABLE

Caliber	Five Station Shell Plate	Primer Size
.17 Remington	10	small
.218 Bee	1	small
.22 Hornet	12	small
.22 K-Hornet	12	small
.22 Remington Jet	6	small
.221 Remington Fire Ball	10	small
.222 Remington	10	small
.223 Remington	10	small
.25-20 Winchester	1	small
.256 Winchester Magnum	6	small
.30 M-1 Carbine	17	small
.30 Luger	16	small
.30 Mauser	16	small
7.62mmX39-.308/.311	32	large
.32 Automatic	17	small
.32 H&R Magnum	23	small
.32 S&W Long	23	small
.32-20 Winchester	1	small
.357 Magnum	6	small
.357 Remington Maximum	6	small
9mm Luger	16	small
.38 Colt Super Auto	1	small
.38 Smith & Wesson	6	small
.38 Special	6	small
.380 Automatic Pistol	10	small
.38-40 Winchester	26/28*	large
10mm Auto Colt	27	large
.41 Remington Magnum	30	large
.44 Magnum	18	large
.44 Special	18	large
.44-40 Winchester	26/28*	large
.45 Automatic	3	large
.45 Auto Rim	8	large
.45 Colt	20	large

The Piggyback will also reload other cartridges that do not exceed 2.260" in overall length. The overall diameter of the .25 Auto case is too small to reload on the Piggyback.

*When two shell plates are listed, the most popular is shown first. It may be necessary to use the alternate depending on the manufacturer and/or lot of cases being used.

STEP 1

The parts required to install the shell plate and to complete the assembly of the indexing system are in Bag #2. Open Bag #2 and check the parts against the drawing on the facing page.

STEP 2

Insert the index ball spring into the hole in the shell plate holder. Place the index ball on top of the spring. See Photo #7. Select the appropriate shell plate and place it (stamped number up) on top of the shell plate holder. Be sure the case retaining springs are not under the edge of the shell plate. Install the ram shoulder bolt through the shell plate and finger-tighten to the shell plate holder. See Photo #8. Use the allen wrench to snugly tighten the ram shoulder bolt. See Photo #9. Do not over-tighten as damage may occur.

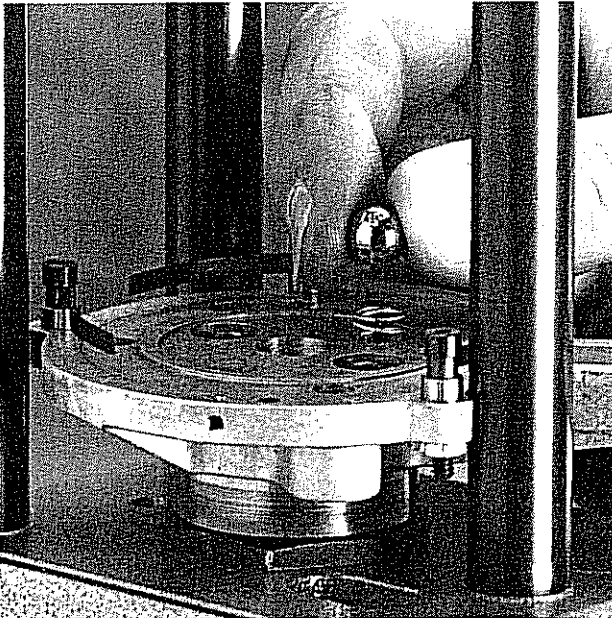

Photo #7: Insert the spring and ball into the hole in the shell plate holder.

The shell plate should turn freely and stop at each station in the proper location.

Care should be taken to maintain the proper location of the index ball during shell plate installation.

STEP 3

After installation of the shell plate, check the position of the case retaining springs. These springs should just touch the shell plate. See Photo #10. The case retaining springs are factory-installed and should not require adjustment.

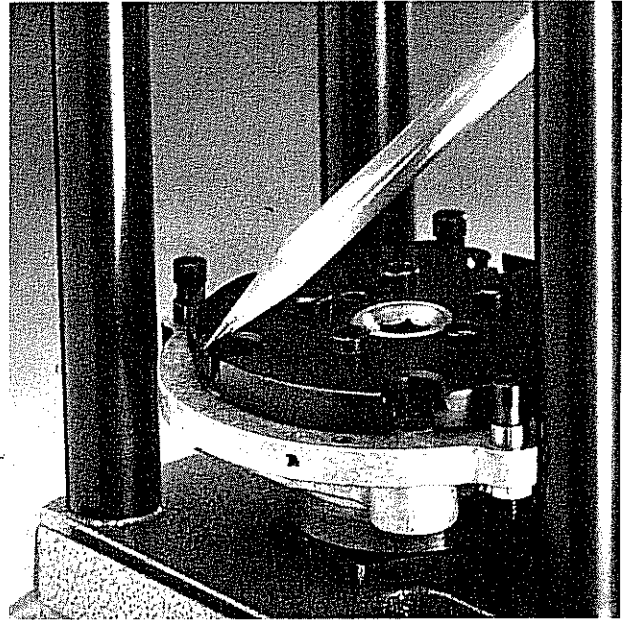

Photo #10: Check the position of the case retaining springs.

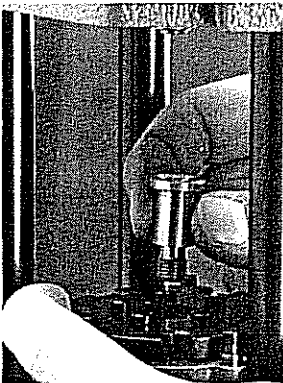

Photo #8: Install the ram shoulder bolt through the shell plate.

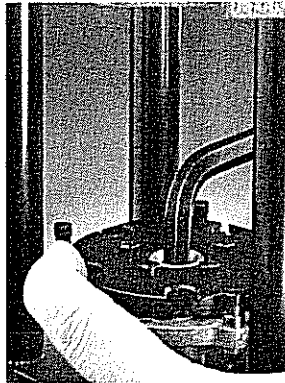
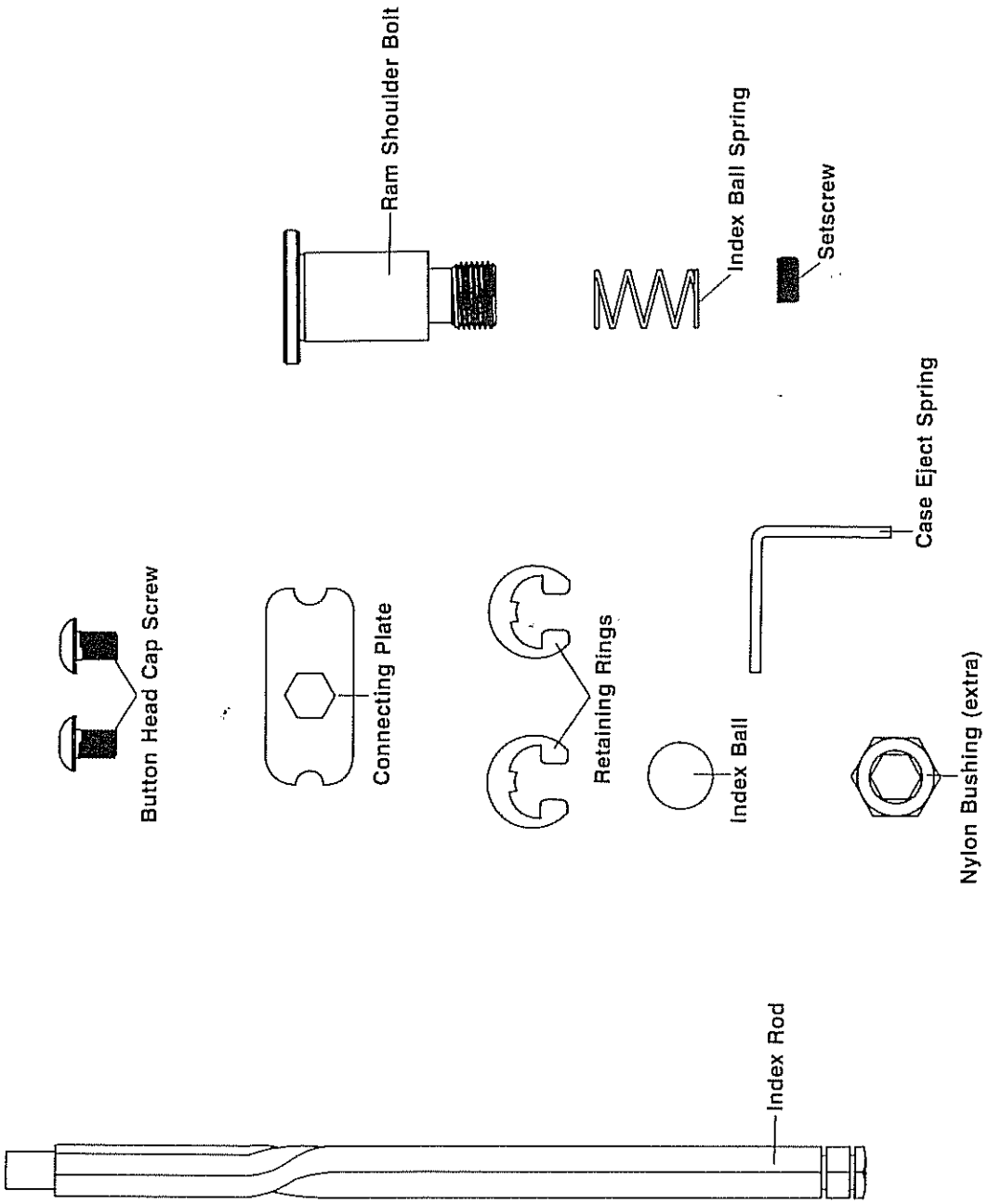

Photo #9: Tighten the ram shoulder bolt.

PARTS FROM BAG #2
(shown actual size)



STEP 4

Clean the index rod. With the twist up, slide the index rod through the index bushing in the top plate, being certain the hex shape of the rod matches the hex shape in the index bushing. See Photo #11.

⚠ CAUTION: INSERT THE INDEX ROD PERPENDICULAR TO AVOID DAMAGING THE INDEX BUSHING.

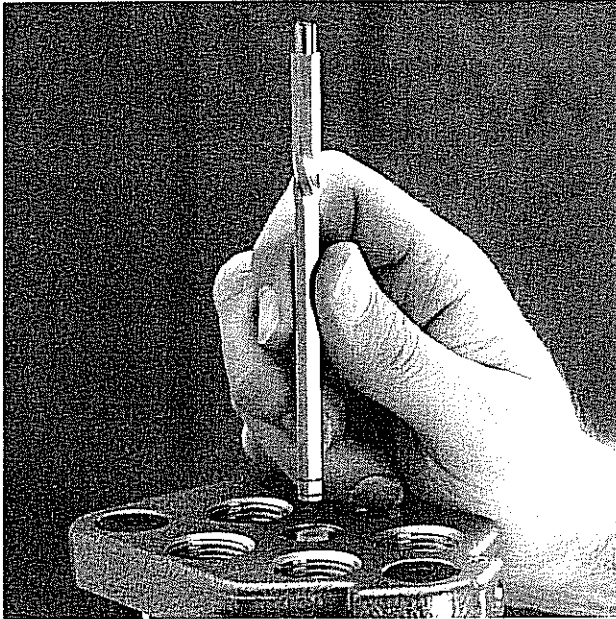

Photo #11: Insert the index rod into index bushing.

STEP 5

Slip the connecting plate onto the bottom of the index rod. See Photo #12. To secure the connecting plate to the index rod, install the bottom retaining ring first (Photo #13), followed by the top retaining ring (Photo #14). The long-nose pliers are helpful in securing the rings in the slots on the index rod.

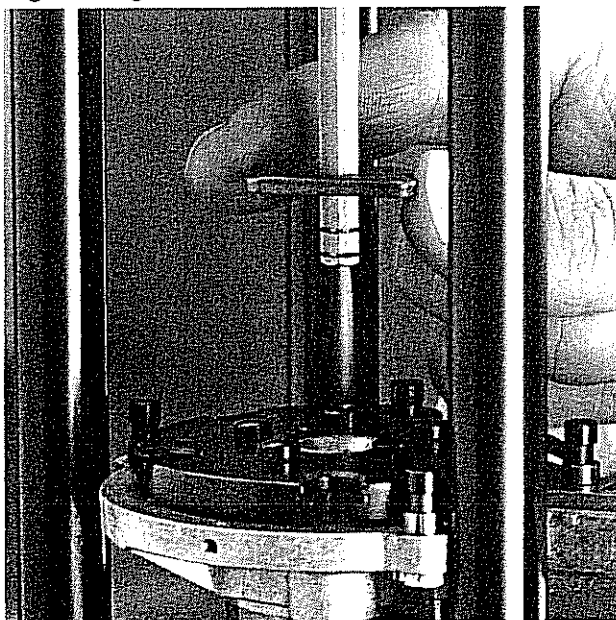

Photo #12: Slip the connecting plate onto index rod.

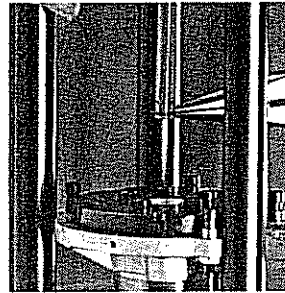

Photo #13: It's easier to install the bottom retaining ring first.



Photo #14: Then, install the top retaining ring.

STEP 6

Lowering the press handle, raise the shell plate to meet the index rod. Rotate the connecting plate in the counter clockwise direction until the large notch in the plate aligns with the raised bump with the threaded hole on the shell plate.

STEP 7

Insert the buttonhead cap screws through the connecting plate and securely tighten to the shell plate using the allen wrench provided. See Photos #15 & 16.

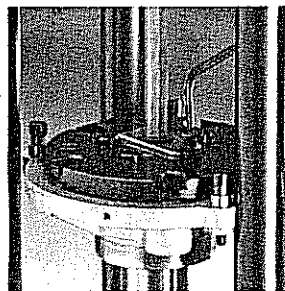

Photo #15: Attach the connecting plate to the shell plate.

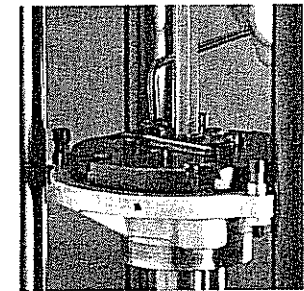

Photo #16: Securely tighten the buttonhead capscrews.

STEP 8

Insert the case eject spring into the small hole located on the shell plate holder. Install the allen setscrew in the left side of the shell plate holder to hold the case eject spring in position. See Photo #17. The final adjustment will be made in another section.

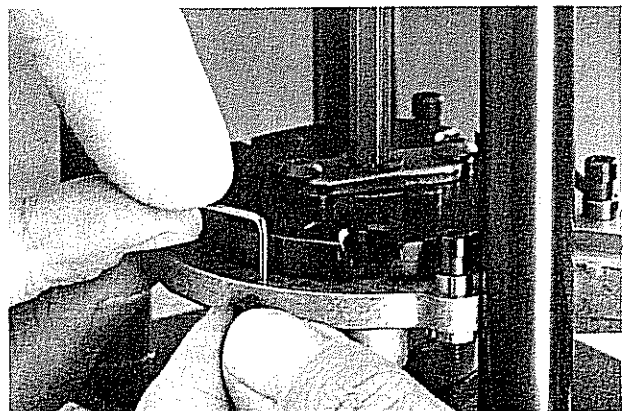

Photo #17: Install the case eject spring and allen setscrew.

AN EXPLANATION OF THE INDEXING SYSTEM

The indexing system on the Piggyback is quite simple and reliable. The hexagonal rod has a 72° twist approximately two inches from the top. As the rod moves up and down with the ram action, the twist passes through the nylon bushing and bearing in the top plate. On the up stroke, the nylon bushing rotates counter clockwise as the twist passes through it. On the down stroke, the one way (clutch) bearing prevents the nylon bushing from rotating back and the twist causes the shell plate to rotate to the next station.

In normal operation, a small amount of resistance will be felt as the twist travels through the bushing in either direction. This resistance is normal. A nylon bushing is used to protect the indexing system against misuse. If the system is forced when jammed, the bushing will be stripped and thus, protect the bearing and index rod from damage.

If the ram travel is reversed part way through the twist, indexing will be incomplete and the shell plate stations will stop in the wrong locations. When this occurs, leave the handle in the up position with no pressure on it and, using your fingers, manually advance the shell plate in a counter clockwise direction to the next station. The system is now correctly aligned for continued use.

To avoid incomplete indexing, always continue ram travel through the twist area of the index rod in both directions.

⚠ CAUTION: IF THE RAM TRAVEL IS REVERSED PART WAY THROUGH THE TWIST, A POWDER CHARGE MAY NOT BE DELIVERED. SET ASIDE ANY CARTRIDGE WHICH MIGHT NOT HAVE A POWDER CHARGE.

⚠ CAUTION: DO NOT TRY TO INDEX THE PRESS IF ABNORMAL RESISTANCE IS FELT. THIS CAN DAMAGE THE NYLON INDEX BUSHING. CHECK THE PIGGYBACK FOR A PROBLEM AND CORRECT IT BEFORE PROCEEDING. REFER TO THE TROUBLE-SHOOTING SECTION ON PAGE 25.

NOTE: DAMAGING THE INDEX ROD WILL CAUSE EXCESS WEAR OF THE INDEX BUSHING.

NOTE: THE INDEXING SYSTEM OPERATES IN ONE DIRECTION (COUNTER CLOCKWISE) ONLY. TRYING TO TURN THE SYSTEM IN THE CLOCKWISE DIRECTION WILL DAMAGE THE INDEX SYSTEM.

STEP 9

Cycle the press several times to gain an understanding of how the indexing system works. Repeat this cycle until you are familiar with the indexing system.

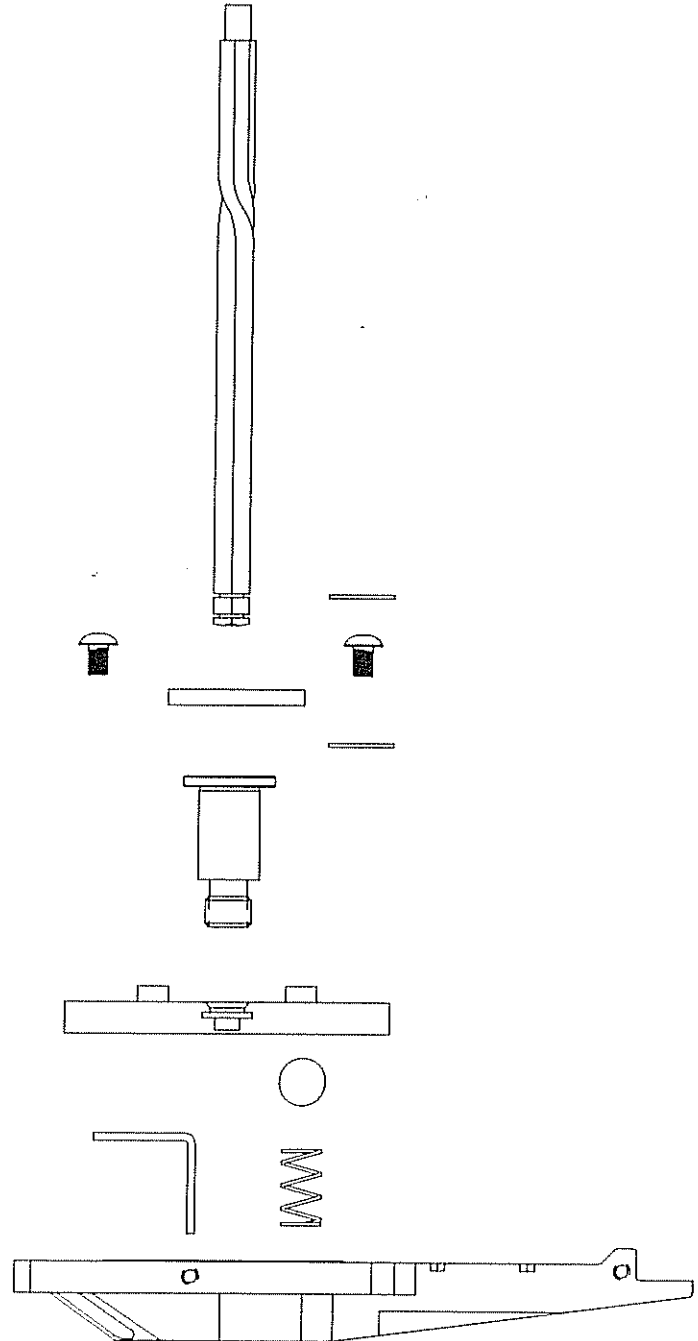

PRIMING SYSTEM

The parts required to assemble and adjust the priming system are in Bag #3. Open Bag #3 and check the parts against the drawing on the facing page.

STEP 1

Place the hex nut on the cam wire clip. See Photo #18. Slide the cam wire into the slot on the clip, making sure the "flat" side of the clip is up. See Photo #19. Slide the clip into the hole in the top plate. See Photo #20. The bottom of the cam wire should be in the counterbored hole in the bottom plate. The counterbored hole is for cam wire location only and is not meant to "hold" or retain the cam wire. Install the setscrew into the top plate but do not tighten. See Photo #21. The cam will need adjustment at a later time.

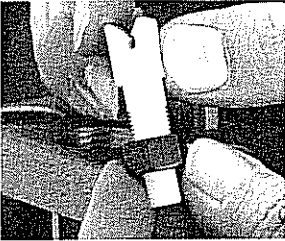

Photo #18: Place the hex nut on the cam wire clip.

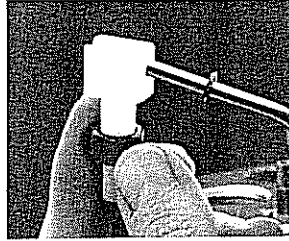

Photo #19: Install the cam wire into the clip.

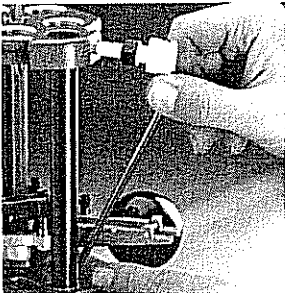

Photo #20: Slide the clip into the top plate.

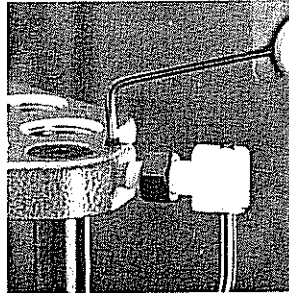

Photo #21: Install the setscrew to hold the clip.

STEP 2

Put the roller on the roller carrier assembly and install the retaining clip. See Photos #22 & 23.



Photo #22: Install the roller on the roller carrier assembly.

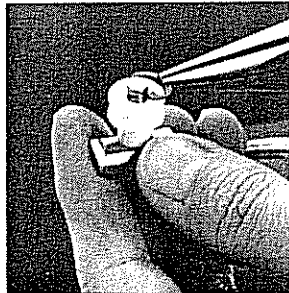
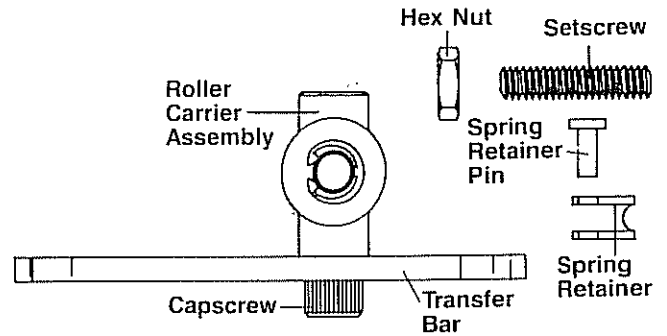

Photo #23: Install the retaining ring.

STEP 3

The Piggyback comes with two transfer bars; one for small primers (stamped with an "S" on the bottom side) and one for large primers (stamped with an "L" on the bottom side). Select the appropriate transfer bar for the primer size you will be using. Refer to the chart on page 7.

Use the spring retainer pin to attach the spring retainer onto the letter-stamped end of the transfer bar. Be sure the "S" or "L" is down when you secure the retainer with the pin from the top.



Attach the roller carrier assembly to the transfer bar with the capscrew. See Photos #24 & 25. Remember, the stamped letter on the transfer bar goes on the bottom. Install the setscrew and hex nut onto the roller carrier assembly. See Photo #26.

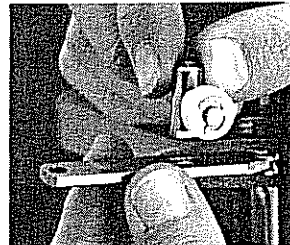

Photo #24: Attach the roller carrier assembly to the transfer bar.

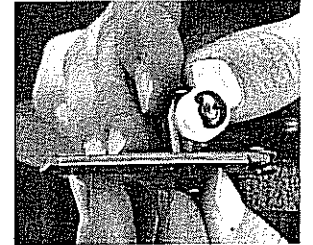

Photo #25: Hold it in place with the cap screw.

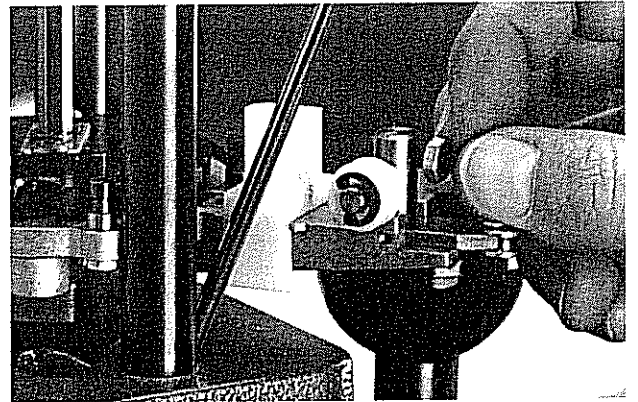
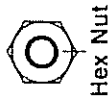

Photo #26: Install the setscrew and hex nut onto the roller carrier assembly.

STEP 4

Select the appropriate primer plug (small plug for small primers and large plug for large primers). Drop

PARTS FROM BAG #3
(shown actual size)



Hex Nut

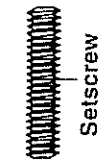

Setscrew

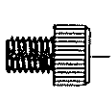

Capscrew



Setscrew

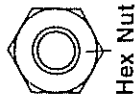

Hex Nut



Setscrew

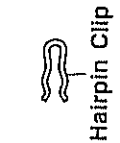

Hairpin Clip

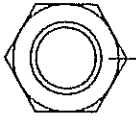

Hex Nut



Setscrew Flathead Screw



Retaining Ring



Spring Retainer

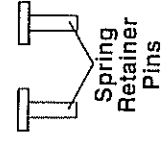

Spring Retainer Pins



Transfer Bar, Large & Small

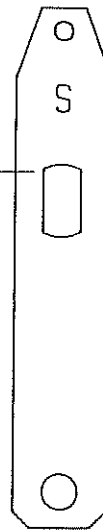

Transfer Bar, Large & Small



Primer Follower

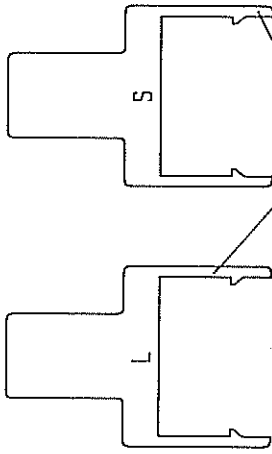

Primer Dispenser, Large & Small

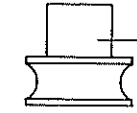

Roller

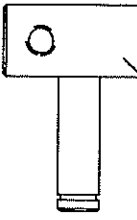

Roller Carrier

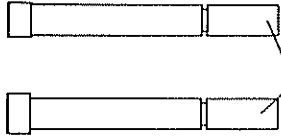

Primer Plug, Large & Small

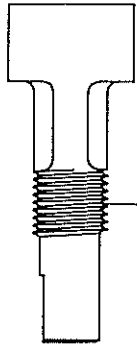

Cam Wire Clip



Return Spring

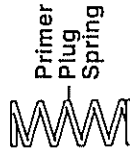

Primer Plug Spring

Cam Wire



Shell Plate Gauge

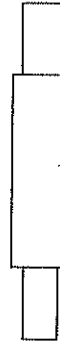

Primer Dispenser Gauge

the plug through the top of the shell plate and the shell plate holder. See Photo # 27. Raise the ram about halfway and turn the shell plate slightly. Slide the primer plug spring over the bottom of the primer plug. See Photo #28. Compress the spring with your finger and install the hairpin clip in the groove. See Photo #29. Use your fingers to advance the shell plate to the next station.

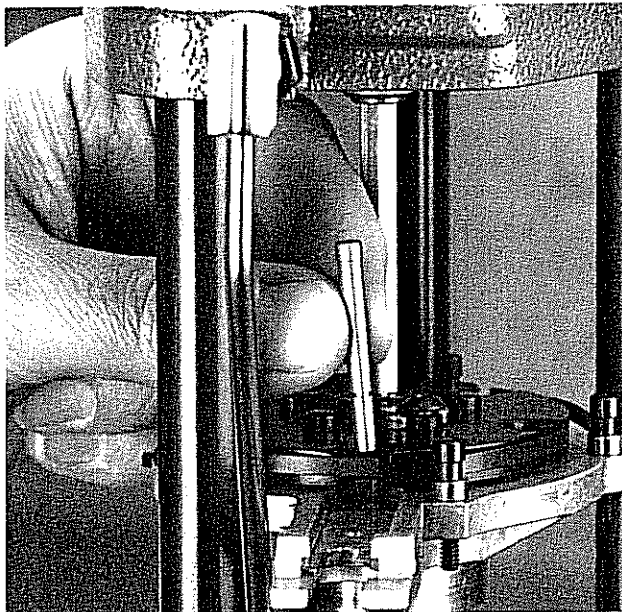

Photo #27: Drop primer plug into hole in shell plate.

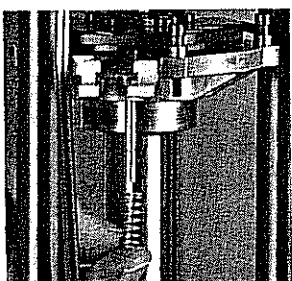

Photo #28: Slide the spring over the bottom of the primer plug.

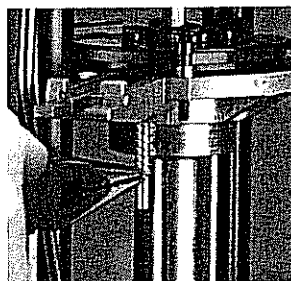

Photo #29: Install the hairpin clip in the groove in the plug.

STEP 5

Install the primer depth setscrew with the hex nut into the bottom plate. See Photos #30 & 31. The final adjustment will be made in another section.



Photo #30: Install the primer depth setscrew.

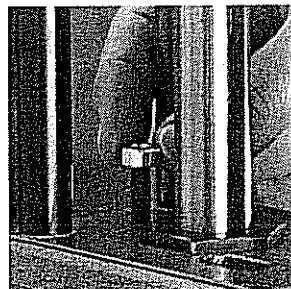

Photo #31: Install the hex nut onto the setscrew.

STEP 6

The Piggyback comes with two primer dispensers; one for small primers (stamped with an "S" on the front) and one for large primers (stamped with an "L" on the front). Select the proper size primer dispenser and snap it onto the shell plate holder with the "S" or the "L" facing out. Make sure it locks firmly in place. See Photo #32.

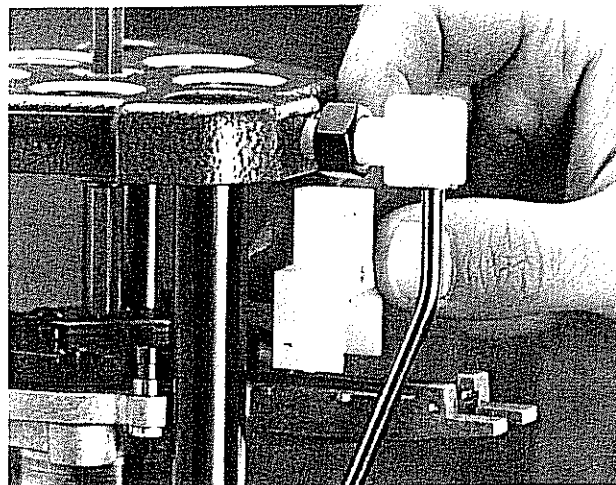

Photo #32: Install the primer dispenser onto the shell plate holder.

STEP 7

Slide the transfer bar into the priming slot on the shell plate holder. See Photo #33. Install one end of the return spring to the *left* side of the shell plate holder using the flat-head screw. See Photo #34. Now install the setscrew (about halfway) into the *right* side of the shell plate holder (see Photo #35) and connect the return spring over the back of the transfer bar. See Photo #36.

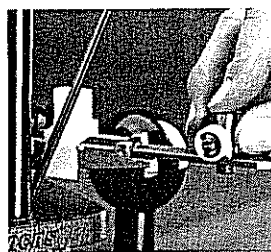

Photo #33: Slide the transfer bar into the priming slot.

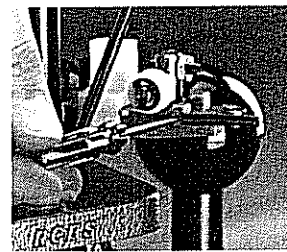

Photo #34: Use the flathead screw for the left side.

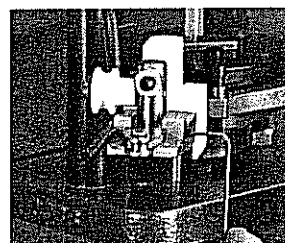

Photo #35: Use the setscrew for the right side.

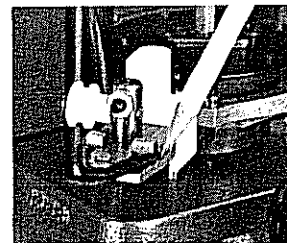

Photo #36: Connect the return spring over the back of the transfer bar.

TRANSFER BAR ADJUSTMENT

Primers are transferred from the primer tube to the primer plug by the transfer bar. The travel of the bar is controlled by the cam wire and the return spring. For the proper transfer of primers, make the two following adjustments:

ADJUSTMENT #1

To adjust the transfer bar at the shell plate, lower the ram to within $\frac{1}{2}$ " of the bottom position. Drop the shell plate gauge, large end or small end (depending on the size or the primer to be used), into the primer hole. See Photo #37. Then, turn the setscrew on the roller carrier until the primer hole is centered over the primer plug and the shell plate gauge drops freely into the primer hole. Hold the setscrew with the allen wrench and tighten the hex nut. The primer plug should move freely in and out of the shell plate as the Piggyback is cycled and indexed. **Remember, the primer plug must be centered in the transfer bar hole.**

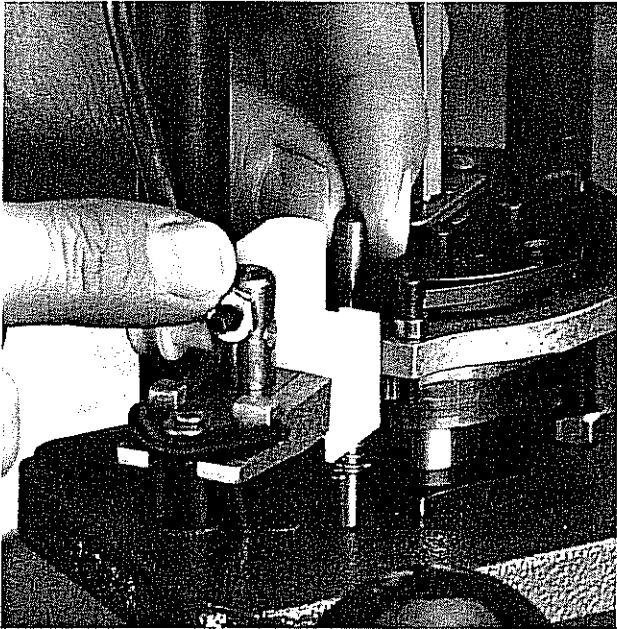

Photo #37: Use the shell plate gauge to adjust the transfer bar at the shell plate.

ADJUSTMENT #2

To adjust the transfer bar at the primer dispenser, raise the ram to the top of the stroke. Loosen the cam wire clip setscrew located in the top plate. Adjust the clip in or out to center the priming hole in the transfer bar under the primer dispenser. This can be done visually or by using the primer dispenser gauge. See Photo #38. Tighten the setscrew and hex nut.

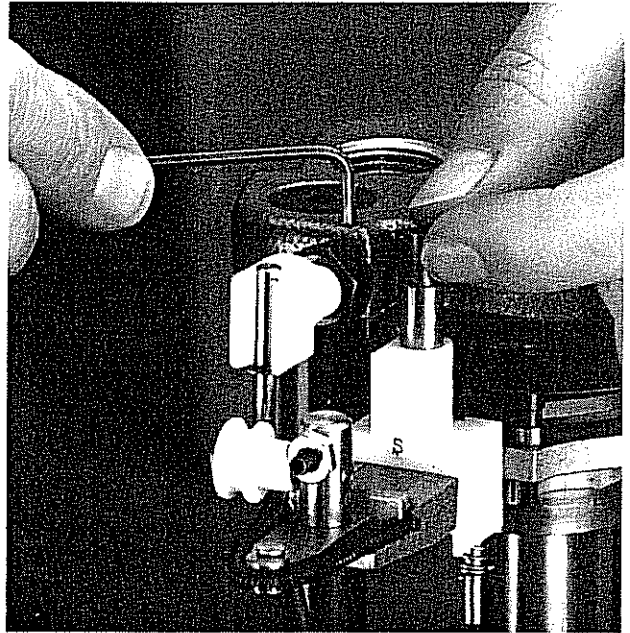

Photo #38: Use the primer dispenser gauge to adjust the transfer bar at the primer dispenser.

STEP 8

Cycle the Piggyback several times to insure the transfer bar is adjusted correctly and to become familiar with this operation.

NOTE: The cam wire is designed to snap free if there is a jam with the transfer bar. The primer dispenser is designed to pop free if there is a jam with a primer. The most likely cause of a jam is incorrect adjustment at the shell plate or dirt under the primer plug. Refer to the Helpful Hints and Trouble Shooting sections in the back of this instruction manual or call us at the factory. Our phone numbers are listed on the back of this manual.

You should have an extra spring retainer pin and a primer follower left over from this assembly operation. The primer follower is a simple device that will alert you when the primer tube has run out of primers. This will be discussed later in more detail.

POWDER DISPENSING SYSTEM

The parts required to assemble and adjust the powder dispensing system are in Bag #4. Open Bag #4 and check the parts against the drawing on the facing page.

STEP 1

Install the swivel on top of the index rod and secure it with the capscrew using the wrench provided. See Photos #39 & 40. The swivel should turn freely on top of the index rod.

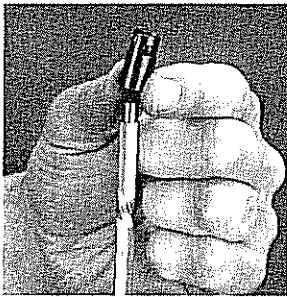

Photo #39: Install the swivel on top of the index rod.

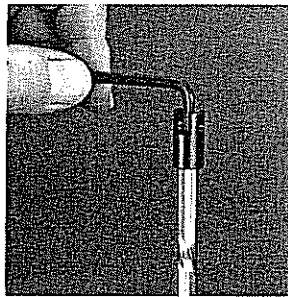

Photo #40: Secure the swivel with the capscrew.

STEP 2

Slide the connecting yoke onto the small diameter of the connecting rod. See Photo #41. Install the retaining ring to hold it in place. See Photo #42.

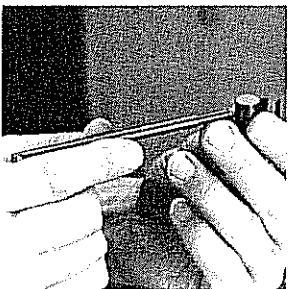

Photo #41: Slide the connecting yoke onto the connecting rod.

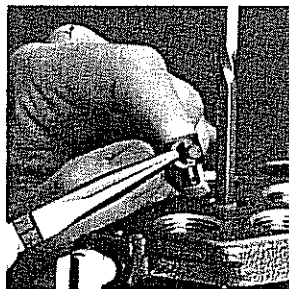

Photo #42: Install the retaining ring.

STEP 3

Attach the connecting rod assembly to the swivel on top of the index rod. Secure it to the swivel with the cross pin. See Photo #43. Hold the cross pin in place by installing the cotter pin. See Photo #44.



Photo #43: Attach the connecting rod assembly to the swivel.

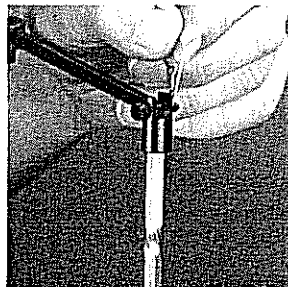

Photo #44: Secure it with the cross pin and cotter pin.

STEP 4

Clean the powder measure adaptor. It must be absolutely free of any oil. We recommend OUTERS® Crud Cutter™ Degreaser. This is a potent degreaser that quickly dissolves grease and oil. Crud Cutter is available from your local sporting goods dealer.

The adaptor can be installed in station #3 or station #4. Select station #3 if bullet seating and bullet crimping are done in two different dies. Otherwise, select station #4.

Screw the adaptor all the way down into the appropriate station in the top plate. See Photo #45.

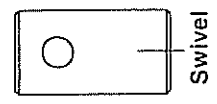

Photo #45: Install the powder measure adaptor into the top plate.

PARTS FROM BAG #4
(shown actual size)



Capscrew



Swivel

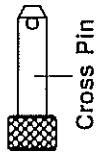

Cross Pin

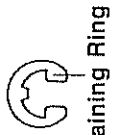

Retaining Ring

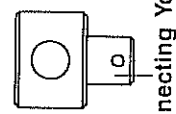

Connecting Yoke

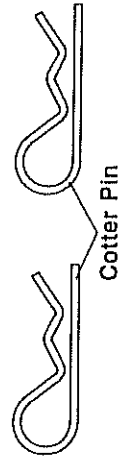

Cotter Pin

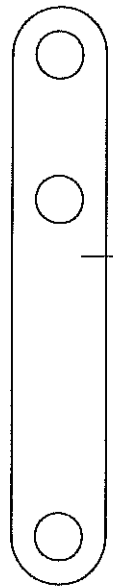

Cylinder Handle

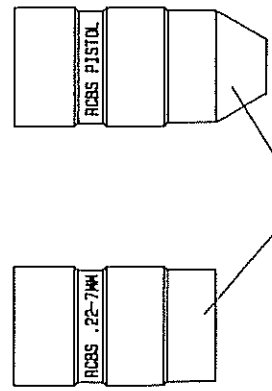

Powder Drop Tubes



Powder Measure Adaptor

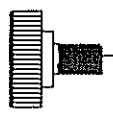

Collar Lock Screw

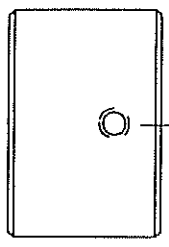

Quick Change Collar

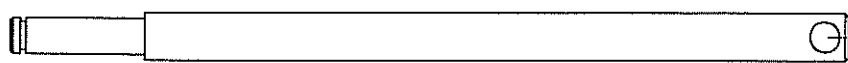

Connecting Rod

STEP 5

Select the appropriate powder drop tube for the caliber you will be reloading. The drop tubes are roll stamped with a caliber range. Thoroughly clean the drop tube inside and out with OUTERS® Crud Cutter.

NOTE: Oil will contaminate gun powder and cause the powder to jam the operation of the powder dispensing system.

Insert the drop tube into the adaptor with the small diameter down. See Photo #46. It will drop freely until it is stopped by a factory-installed retaining ring near the bottom of the adaptor.



Photo #46: Insert the powder drop tube into adaptor.

STEP 6

The powder measure linkage for the Piggyback is designed for use **only** with the RCBS® Uniflow™ Powder Measure. To convert your Uniflow Powder Measure to automated use, first remove the handle from the cylinder. See Photo #47. Replace it with the cylinder handle from Bag #4, using the same screws from your powder measure handle. See Photo #48.

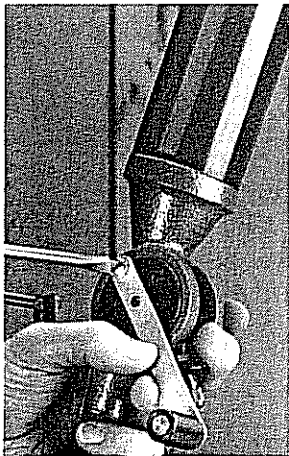

Photo #47: Remove the handle from the Uniflow Powder Measure.

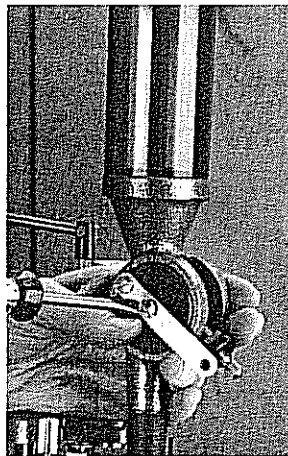

Photo #48: Replace it with the cylinder handle.

STEP 7

Remove the plastic drop tube from the bottom of the powder measure. Install the hex lock ring that came with your powder measure. Thread the quick-change collar approximately half-way onto the bottom of the powder measure. See Photo #49.

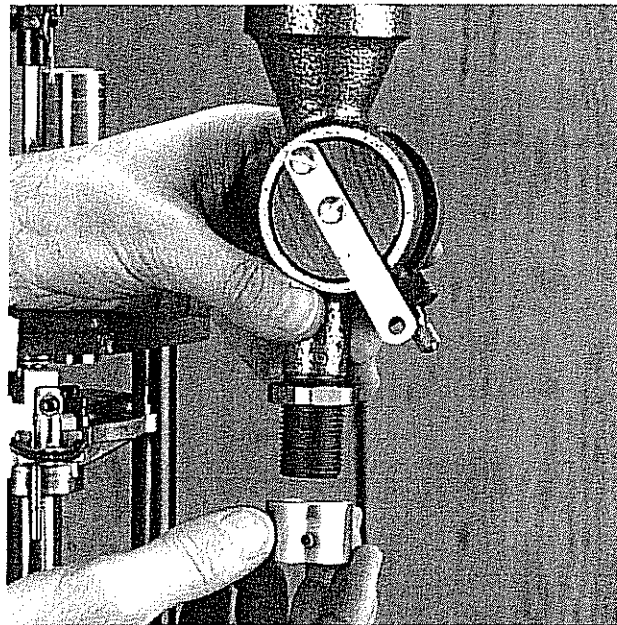

Photo #49: Thread the quick-change collar onto the powder measure.

STEP 8

Slide the powder measure onto the adaptor. The quick-change collar will slide over the adaptor. Install the collar lock screw but do not tighten. **Rotate the collar so the lock screw is towards the back of the tool.** See Photo #50.



Photo #50: Position the collar so the lock screw is towards the back of the tool.

STEP 9

Position the powder measure as indicated in Photo #50. Connect the yoke to the cylinder handle. See Photo #51. Secure the yoke with the cotter pin. See Photo #52.

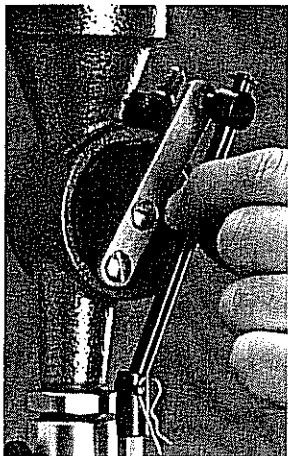

Photo #51: Connect the yoke to the handle.

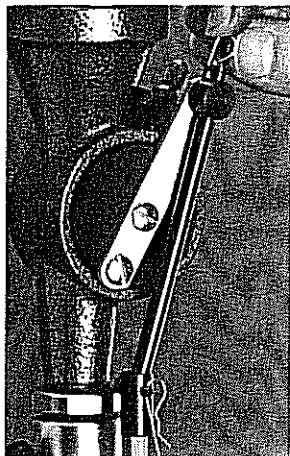

Photo #52: Secure the yoke with the cotter pin.

STEP 10

Now you are ready to adjust the powder measure height. Use one of the two following methods, depending on which press you are using.

If you are using a Rock Chucker Press, use these instructions. Lower the ram and shell plate to the very bottom. Turn the quick-change collar (while holding the powder measure in place) to adjust the height. Adjust it until the powder measure handle is at the very bottom of its stroke. Angle the powder measure as shown in Photo #50 and lock the quick-change collar with the collar lock screw. Be certain the lock screw is in the back.

If you are using a Reloader Special-3 Press, use these instructions. Lower the ram and shell plate to the very bottom. Turn the quick-change collar (while holding the powder measure in place) to adjust the height. Adjust it until the powder measure handle is at the bottom of its stroke. Then, turn the collar one full revolution, counter clockwise, to position the handle correctly. Angle the powder measure as shown in Photo #50 and lock the quick-change collar with the collar lock screw in the back.

NOTE: Be sure the press ram is at the very bottom of its stroke or this adjustment will not be correct.

STEP 11

Lock the powder measure hex lock ring against the quick-change collar. Cycle the Piggyback several times to insure that the powder measure cylinder handle rotates the full cycle. Rotate the powder measure to remove any binding in the linkage.

STEP 12

To assemble the depriming bottle and spent primer tube, insert the white plastic tube (with a slight twisting motion) into the top of the depriming bottle cap. Slide the other end of the tube through the slot in the bottom of the bottom plate. Screw the tube into the shell plate holder at station #1. See Photo #53.

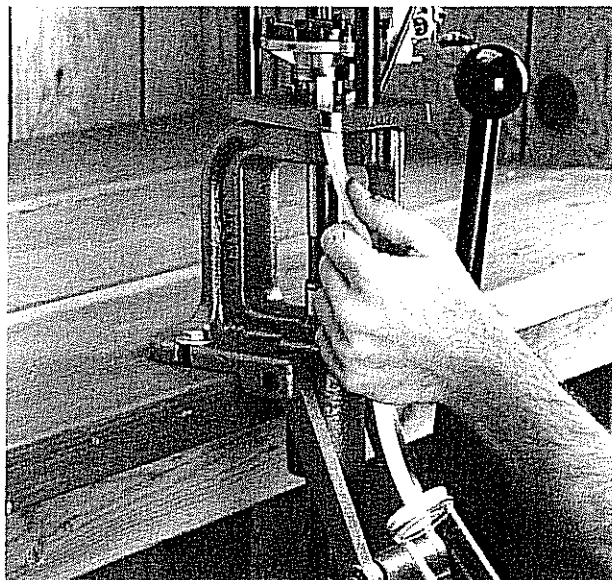

Photo #53: Install the spent primer tube.

STEP 13

The ammo catcher box mounts on the left side of the bottom plate. The lip on the back side of the box slides into the slot. See Photo #54.

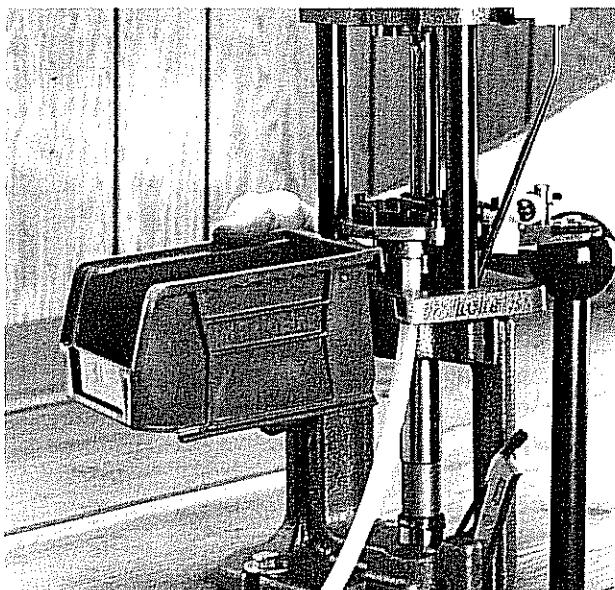

Photo #54: Install the ammo catcher box.

This completes the basic assembly process of the Piggyback. If you have any questions at this point, stop and call us using the phone numbers printed on the back of this safety and instruction manual.

GENERAL ORIENTATION

The sequential reloading operations take place in the five die stations and the corresponding positions in the shell plate. The shell plate rotation is in the **counter clockwise** direction. Shown below is a chart that outlines the different operations that take place at each shell plate station.

Station	Bottle-neck Cases	Bottle-neck Cases with Lube Die
#1	Size & Deprime	Lube & Deprime
#2	Prime	Size & Prime
#3	Skip Station	Skip Station
#4	Powder Charge	Powder Charge
#5	Seat (& Crimp*) Bullet	Seat (& Crimp*) Bullet

*Only Bullets with Cannelure.

Station	Straight-Wall Cases with combined bullet seating & crimping	Straight-Wall Cases with separate bullet seating & crimping
#1	Size & Deprime	Size & Deprime
#2	Prime & Expand Case Mouth	Prime & Expand Case Mouth
#3	Skip Station	Powder Charge
#4	Powder Charge	Seat Bullet
#5	Seat & Crimp Bullet	Crimp Bullet

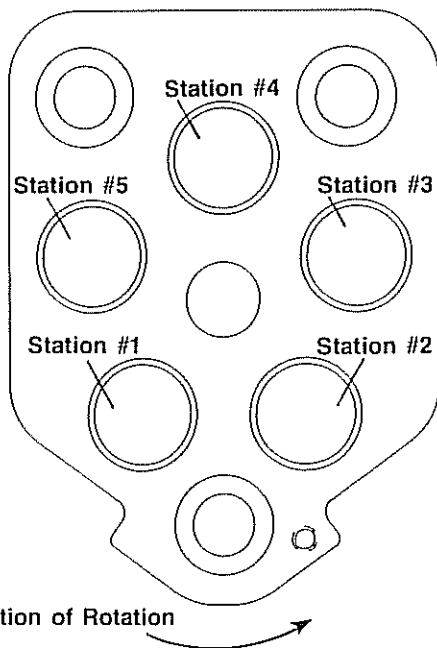

DIE INSTALLATION

Refer to the instructions received with your reloading die set for the proper installation of the dies in the Piggyback. Adjust the dies the same as you would in a single-stage press. The Piggyback is designed to use dies with hex steel lock rings only. Some older RCBS dies were manufactured with a knurled aluminum lock ring. These aluminum lock rings will not fit on a five-station top plate. That is why we have included three hex steel lock rings in Bag #1. Additional rings are available from your dealer or call RCBS.

PRIMER FEED TUBE FILLING

⚠ WARNING: CARE MUST BE TAKEN WHEN LOADING THE PRIMER FEED TUBE. DO NOT FORCE PRIMERS. BECAUSE OF THE STACKED CONDITION OF THE PRIMERS, IF ONE SHOULD IGNITE, ALL THE PRIMERS IN THE TUBE WILL EXPLODE CAUSING AN EXTREME HAZARD. NO MORE THAN FIVE POUNDS OF FORCE SHOULD BE APPLIED WHEN PICKING UP PRIMERS WITH THE PRIMER FEED TUBE (THIS CAN BE CHECKED USING A BATHROOM SCALE). IF DIFFICULT PRIMER PICK-UP SHOULD OCCUR, INVESTIGATE THE CAUSE AND CLEAR THE CONDITION OR RETURN THE PRIMER FEED TUBE TO RCBS FOR CORRECTION. ALWAYS WEAR EYE PROTECTION WHEN HANDLING PRIMERS.

We recommend the primer feed tubes be used in conjunction with the RCBS Primer Tray. This plastic primer tray and cover have been designed to orient primers for fast, easy handling and primer pick-up with the primer feed tubes.

First, gently scatter the primers onto the grooved surface of the primer tray. Then, gently shake the tray horizontally until all the primers are positioned anvil side up. Place the cover on the tray and, while holding the tray and cover together, turn the tray upside down. The primers will now be oriented anvil side down for easy pick-up with the appropriate size primer feed tube. See Photo #55. Insert the primer feed tube cotter pin in the cross hole before picking up any primers. It will be removed after the tube is inserted into the priming system.

⚠ WARNING: IT IS THE RESPONSIBILITY OF THE OPERATOR TO INSURE THAT ALL PRIMERS ARE PROPERLY ORIENTED. ATTEMPTING TO SEAT A PRIMER UPSIDE DOWN IN A CASE MAY CAUSE THE PRIMER TO DETONATE CAUSING SERIOUS PERSONAL INJURY OR DAMAGE TO THE EQUIPMENT.

Use the end of the tube opposite the cotter pin for primer pick-up. After filling, insert the tube, cotter pin end down, into the primer dispenser. The cotter pin

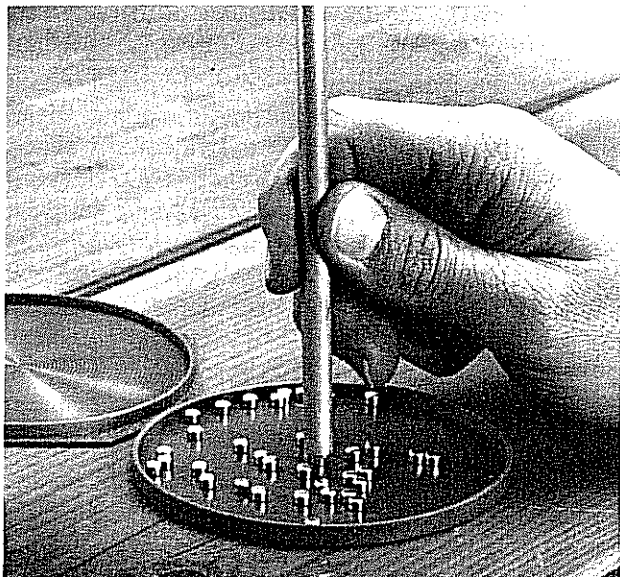

Photo #55: Use an RCBS Primer Tray to correctly position primers for easy pick-up with the tubes.

can then be removed from the tube. The tube holds 100 primers.

After installing the primer tube in the primer dispenser, insert the primer follower (included in Bag #3) small end down, into the top of the tube. See Photo #56. When the last primer is used from the tube, the primer follower will drop down and alert you to the fact that you are out of primers. See Photo #57.

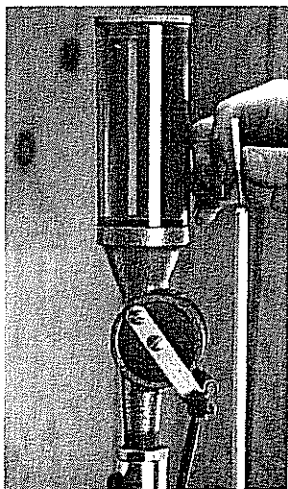

Photo #56: Drop the primer follower into the full primer tube.

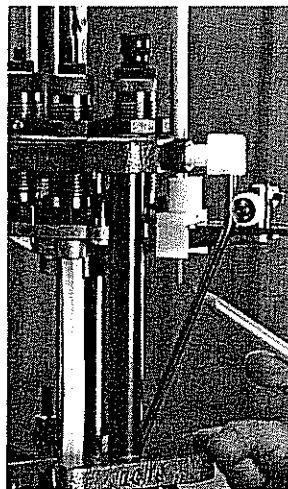

Photo #57: The primer follower will alert you when the tube is empty.

⚠ WARNING: DO NOT EXPOSE PRIMERS TO HEAT, PRESSURE OR TO STATIC ELECTRICITY. THESE CONDITIONS CAN CAUSE PRIMERS TO DETONATE! CLEAN THE PRIMER TUBES EVERY 500 ROUNDS TO REMOVE DANGEROUS PRIMER RESIDUE. CLEAN THE PRIMER TUBES WITH A MILD DETERGENT AND WATER.

⚠ WARNING: DO NOT STORE PRIMERS IN THE PRIMER TUBES. RETURN ANY UNUSED PRIMERS TO THEIR ORIGINAL FACTORY PACKAGING.

POWDER MEASURE

When the powder measure linkage is aligned correctly, remove the cotter pin and disconnect the yoke from the cylinder handle. Powder may now be added to the hopper. Adjust the powder measure for the proper charge. Refer to the Uniflow Powder Measure instructions.

⚠ WARNING: THE OPERATOR IS SOLELY RESPONSIBLE FOR ALL ASPECTS OF THE POWDER DISPENSING SYSTEM. EITHER AN INSUFFICIENT OR EXCESS POWDER CHARGE CAN RESULT IN GUN DAMAGE AND SERIOUS PERSONAL INJURY.

⚠ WARNING: BE CERTAIN THAT THE CORRECT TYPE OF POWDER IS USED AND THAT THE POWDER MEASURE DOES NOT RUN OUT OF POWDER. CONFIRM ON AN ACCURATE RELOADING SCALE THAT THE CORRECT CHARGE IS BEING DISPENSED.

⚠ WARNING: BE ABSOLUTELY CERTAIN THAT ONLY ONE CHARGE IS DISPENSED INTO EACH CARTRIDGE. NO MORE, NO LESS. IF IN DOUBT, CHECK THE CASE POWDER CHARGE PRIOR TO SEATING THE BULLET. REFER TO THE LATEST SPEER® RELOADING MANUAL FOR SAFE POWDER HANDLING AND STORAGE INSTRUCTIONS.

NOTE: Remember to connect the yoke to the powder measure only when a sized and primed case is located at the powder dispensing station. Powder will automatically dump with each pull of the handle when the yoke is connected.

NOTE: The powder measure can be quickly removed from the adaptor by disconnecting the yoke, loosening the collar lock screw and removing the entire unit. The powder measure can be replaced without losing the height adjustment.

⚠ WARNING: THE "FLOW" CHARACTERISTICS OF POWDER VARIES CONSIDERABLY DUE TO WEATHER, OPERATOR TECHNIQUE AND OTHER FACTORS INHERENT TO THE POWDER ITSELF. LONG AND/OR LARGE GRANULED POWDERS MAY TEND TO "BRIDGE" IN THE POWDER DROP SYSTEM AND CAUSE ERRATIC CHARGE WEIGHT. BE CERTAIN THAT THE POWDER YOU SELECT FLOWS FREELY THROUGH THE POWDER DISPENSING SYSTEM. BALL POWDER SHOULD BE USED IN ALL PROGRESSIVE RELOADING TOOLS.

PIGGYBACK OPERATION

After completing the assembly and installation procedure, the Piggyback is ready for operation.

STEP 1

Place a fired case in the shell plate at station #1. See Photo #58. Lower the handle and the fired case will enter the sizer die. See Photo #59. The case will be sized and the spent primer will be ejected. The spent primer will fall through the spent primer tube and into the bottle. Place a fired case in station #1 prior to each pull of the handle. As the ram travels upward, the primer transfer bar will pick up a primer from the dispenser. Be sure the cotter pin is removed from the primer tube.

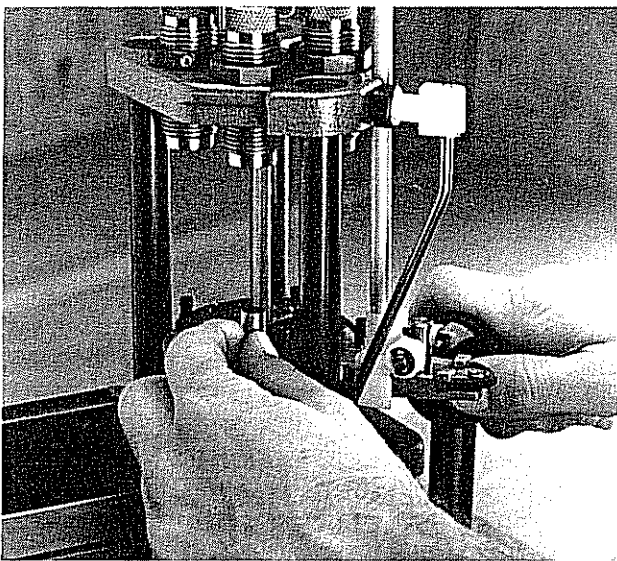

Photo #58: Place a fired case at station #1.

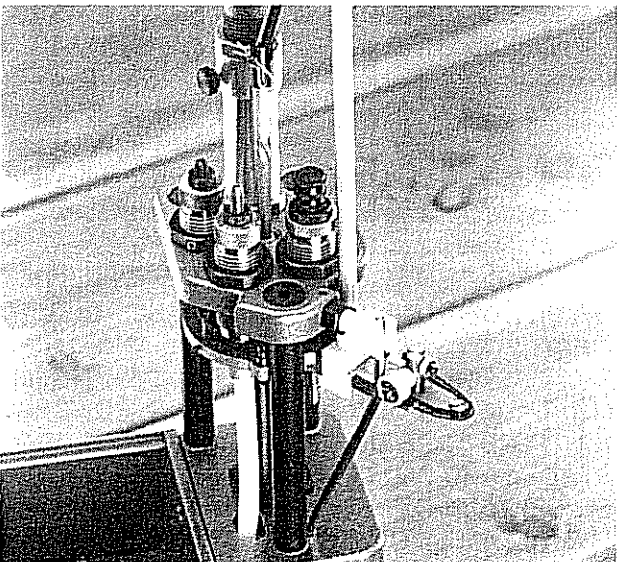

Photo #59: This shows the ram at the top of the stroke with the case in the sizer die.

STEP 2

Raise the handle. As the case is lowered it will automatically index to station #2. As the press is cycling, the primer transfer bar will deliver a primer to the priming station. The design of the Piggyback allows you to see the primer in the transfer bar. You can confirm the primer is there and anvil up. Develop the habit of visually checking the primer in the transfer bar with each up stroke of the handle. Use a firm force to seat the new primer into the sized and deprimed case. Using a smooth constant stroke, with a pause at the top of the handle travel before seating the primer, will help develop the ability to "feel" the proper primer seating. Remember, priming is done in the top few inches of handle travel.

NOTE: Developing the ability to "feel" a primer being properly seated is one of the most important traits of an experienced reloader. This ability not only assures proper seating depth but also makes you aware if something is wrong. If it doesn't "feel" right, stop and check your work.

⚠ WARNING: DO NOT ATTEMPT TO PRIME MILITARY CARTRIDGE CASES WITH CRIMPED PRIMER POCKETS UNTIL THE CRIMP HAS BEEN REMOVED BY SWAGING. PRIMERS SEATED INTO CRIMPED POCKETS ARE SUBJECT TO DEFORMATION WHICH CAN CAUSE MISFIRES AND EVEN DETONATION DURING SEATING WHICH CAN CAUSE PERSONAL INJURY.

⚠ WARNING: DO NOT ATTEMPT TO SEAT PRIMERS AGAINST EXCESSIVE RESISTANCE WHICH MIGHT CAUSE DETONATION AND POSSIBLE PERSONAL INJURY. CHECK TO BE CERTAIN THAT THE CASE WAS NOT PREVIOUSLY PRIMED, THAT THE FIRED PRIMER WAS REMOVED, THAT A PORTION OF THE PRIMER CUP WALL MIGHT STILL BE IN THE PRIMER POCKET AND THAT YOU ARE USING THE CORRECT SIZE PRIMER.

⚠ WARNING: DO NOT MODIFY THE PIGGYBACK PRIMING SYSTEM OR PARTS IN ANY MANNER OR ATTEMPT TO USE SIMILAR PARTS OR PRIMING SYSTEMS FROM OTHER MANUFACTURERS. DO NOT USE THE PIGGYBACK PRIMING SYSTEM ON ANY OTHER RELOADING PRESS. TO DO SO COULD RESULT IN PRIMER DETONATIONS RESULTING IN PERSONAL INJURY.

STEP 3

The primer seating depth is adjusted by the primer depth screw on the bottom plate. See Step 5 on page 14. Start the adjustment process with the screw too high and adjust the screw downward until the primers are seated to the correct depth. Pull each case out of the shell plate at the priming station and visually check the depth of the seated primer. Ideally, the primer should be .002 to .005 below flush.

⚠ WARNING: DO NOT SLAM THE PRIMER TRANSFER BAR. THIS CAN CAUSE A PRIMER TO DETONATE, CAUSING SERIOUS PERSONAL INJURY.

⚠ WARNING: PRIMERS NOT SEATED BELOW FLUSH OF THE CARTRIDGE CASE HEAD CAN RESULT IN A "SLAM-FIRE": THIS IS A CONDITION WHEREIN THE CARTRIDGE FIRES INADVERTENTLY AS THE GUN MECHANISM IS CYCLED. A "SLAM-FIRE" CAN RESULT IN SERIOUS PERSONAL INJURY AND EQUIPMENT DAMAGE.

NOTE: Pick up any loose primers at once, including primers that have dropped through to the bottom plate. Do not let them accumulate on the shell plate holder.

STEP 4

After you are satisfied with primer seating, place a fired case in station #1. See Photo #60. Lower the handle and the primed case will enter the neck expander die (on pistol cases) in station #2. Here the case mouth is expanded to accept a bullet at the bullet seating station. As the handle is raised and the shell plate is lowered, the case automatically indexes to the powder dispensing station. Don't forget to seat the next primer in station #2. If the powder measure is installed in station #3, it is now time to connect the powder measure

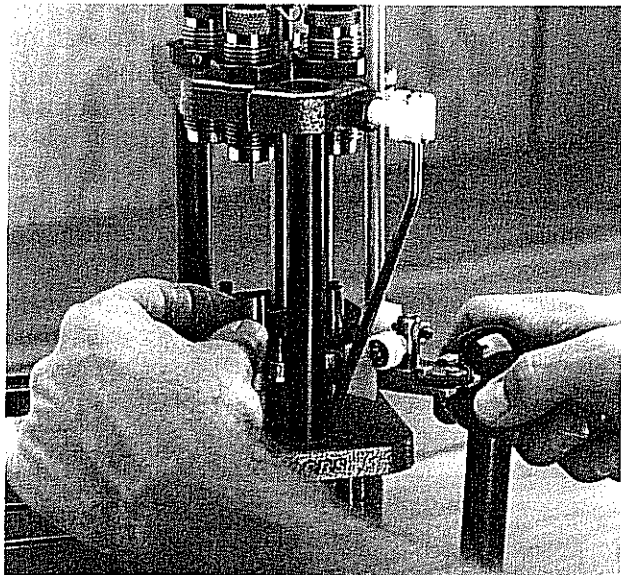

Photo #60: Place another fired case at station #1.

connecting yoke to the cylinder handle and secure with the cotter pin. If the powder measure is in station #4, wait for one more cycle of the press prior to connecting the powder measure connecting yoke.

NOTE: Always disconnect the powder measure yoke prior to cycling the Piggyback when a primed and sized case is not at the powder dispensing station. But, don't forget to reconnect the powder measure when you are ready to charge cases.

STEP 5

Place a fired case into station #1. See Photo #61. By lowering the handle again a case will enter the powder measure adaptor. The powder will automatically be dispensed into the case. As the case is lowered it will index to the next station.

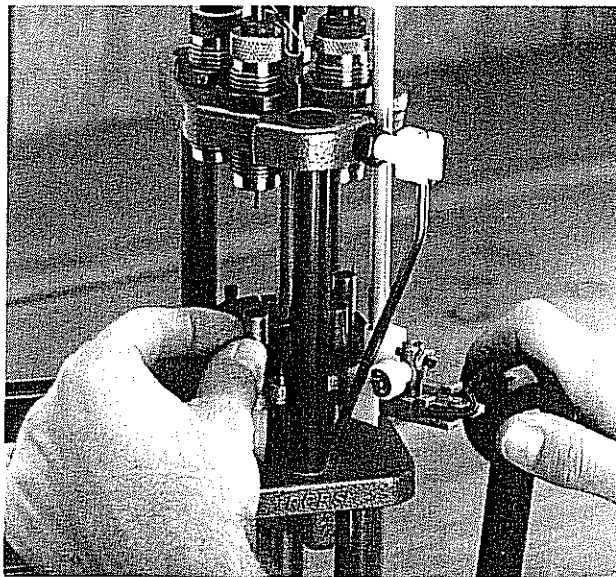

Photo #61

NOTE: This is an excellent time to pull the case from the shell plate and check the powder charge on an accurate reloading scale. The case can be returned to its proper position by pushing it against the case retaining spring and letting it slip back into the shell plate.

STEP 6

Station #4 should be used for bullet seating if a separate bullet crimping operation is desired. If seating and crimping is done in one operation, leave station #3 empty. See Photo #62. By cycling the Piggyback the case is indexed to station #5.

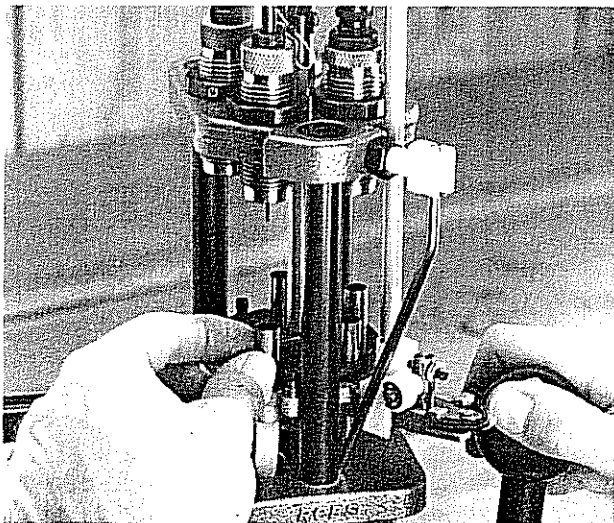

Photo #62

STEP 7

At the bullet seating station, hold a bullet on top of the case (see Photo #63) and guide it into the seater die as the handle is lowered. The bullet will be seated and crimped (if desired). As the handle is raised the cartridge will lower and index to the case eject spring.

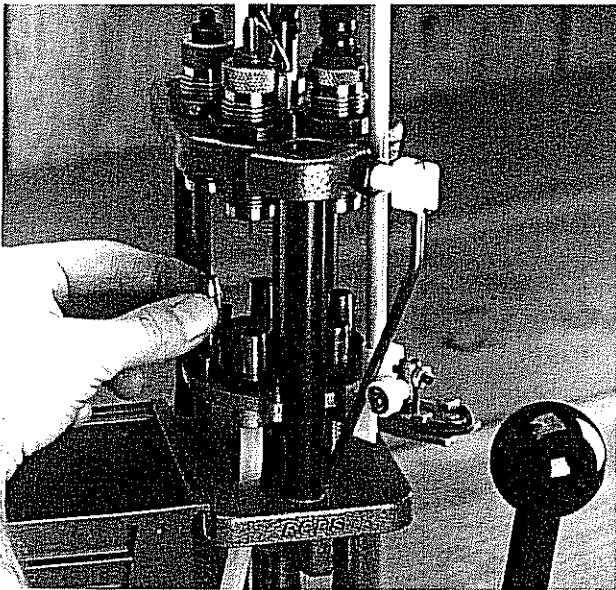

Photo #63: Hold a bullet on top of the case at the bullet seating station.

The case eject spring should catch the case near the end of the spring. Take time to adjust it. Properly adjusted, the case eject spring will be approximately $\frac{1}{4}$ " from the base of the shell plate. See Photo #64. The case ejection spring will remove the cartridge from the shell plate and eject it into the ammo catcher box, mounted on the bottom plate of the Piggyback.

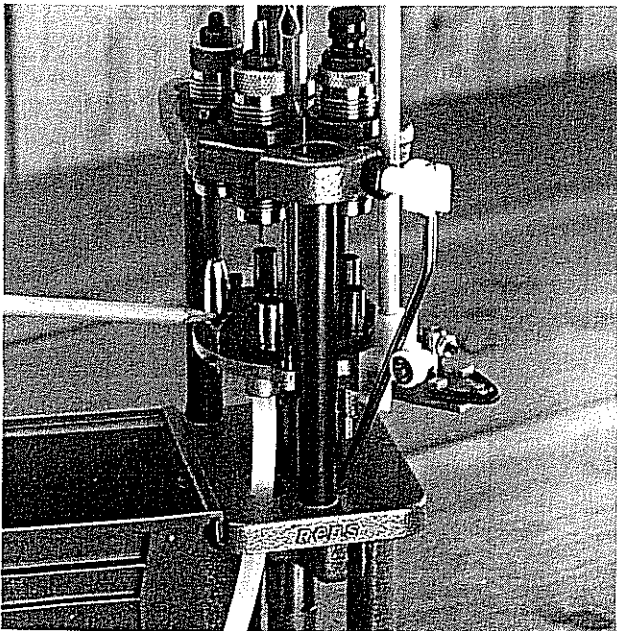

Photo #64: Take time to properly adjust the case eject spring.

NOTE: Take the reloaded cartridge and examine the primer seating depth, the bullet seating depth and the crimp of the bullet. Examine each cartridge until fully satisfied with each operation being performed by the press.

NOTE: Remember that each step is performed with every cycling of the press. Go slow at first until you are comfortable and satisfied with each operation of the Piggyback. Safety is more important than speed.

NOTE: If the handle is forced, this will cause the index rod to expand the nylon bushing. If the nylon bushing becomes damaged, it will need to be replaced. An extra nylon bushing is included in Bag #2. To replace: Remove the index rod from the Piggyback. Using a small screwdriver, remove the retaining ring (the ring has a small hook on one end for a screwdriver) from the top of the indexing assembly. Push the damaged nylon bushing out from the bottom. Install the new nylon bushing. Push down on the retaining ring to snap it into place. Install the index rod.

HELPFUL HINTS

- Develop a habit of watching the transfer bar move from the primer tube to the priming station. This will confirm that a primer is in place, and that the primer is anvil up.
- Starting with an equal amount of primers and bullets (such as a box of 100 primers and a box of 100 bullets) you will know how many primers you have in the primer tube by the number of bullets remaining. Also, if you use the primer follower, you will know when the tube is empty.
- Box the reloaded ammunition in an orderly manner. Avoid dumping the loaded rounds into a large container. An occurrence such as an empty powder hopper will not affect the entire lot.
- **Reload alone. Do not let anyone or anything distract you.**
- If you have the slightest doubt whether a particular round contains powder, set it aside. An empty round cannot necessarily be detected by weighing or shaking. **TAKE NO CHANCES!** Pull the bullet if you have any doubts.
- Develop the habit of running your finger across the case head while boxing the ammunition. A primer protruding as little as .001 of an inch can be detected, by feel, with practice.
- Save these instructions for future reference.
- Keep the Piggyback and the reloading area neat and clean. This will help insure good operation of the tool. A can of canned air, such as OUTERS Grit Getter,[™] can be helpful in cleaning hard-to-reach areas of the tool.

- Remove the operating handle to prevent unauthorized operation.
- Be sure to cycle the operating handle all the way up and all the way down. Remember, primer seating is done in the top few inches of handle travel. There will be some slight resistance in this position.

TROUBLE SHOOTING

Refer to this section for help in solving any specific problems you might encounter while operating the Piggyback. If you need additional help, refer to the phone numbers on the back of this manual. Call us at the factory and we'll be glad to help. Many times, a problem can be solved over the phone.

Shell plate does not rotate:

- Fired primer was not pushed clear of the shell plate
- Fired primers stacked in the depriming tube
- Dirt or debris under the shell plate
- Decapping pin stuck in small flash hole
- Connecting plate not attached to the shell plate

Shell plate does not rotate completely:

- Damaged index bushing
- Travel of the index rod only partially through the twist (short handle stroke)

Primer seated upside down or sideways:

- Primer picked up wrong when primer tube was loaded
- Incorrect primer transfer bar installed
- Case retaining spring not properly adjusted
- Primer transfer bar not properly adjusted
- Incorrect primer tube

Deformed primer during seating:

- Using military case with crimped primer pocket
- Wrong primer size
- Incorrect primer plug and primer transfer bar
- Case retaining spring not properly adjusted
- Primer transfer bar not properly adjusted

Primer transfer bar did not pick up a primer:

- Empty primer tube
- Wrong primer size
- Primer transfer bar not properly adjusted
- Incorrect primer dispenser
- Wrong transfer bar

Spilled powder at station #3 or station #4:

- Wrong or absence of powder drop tube
- Powder drop tube installed upside down
- Powder measure adaptor needs cleaning
- Excessive powder charge
- Lowering the ram too fast
- Case not at powder station

- Powder selection not suited for the Piggyback

- No primer in case

Fired case hangs up trying to enter the sizer die:

- Case not fully inserted into the shell plate
- Inadequate entry chamfer on die (common to some older dies)

Priming system will not seat primers:

- Primer depth screw not properly adjusted
- Incomplete indexing
- Incorrect transfer bar adjustment at the shell plate
- Primer has dropped in front of transfer bar, therefore restricting travel

Primer transfer bar fails to move freely:

- Accumulation of dirt in the transfer bar slot
- Accumulation of dirt under the plug

CARE AND MAINTENANCE

Use the following information as well as the care and maintenance instructions that came with your reloading press, powder measure, and reloading dies.

- Keep the Piggyback clean at all times
- Promptly clean up any powder spills
- Remove any spilled powder from under the shell plate
- Keep the priming station clear of any foreign objects
- Occasionally oil the ram
- Develop the habit of thoroughly cleaning the Piggyback every 500 rounds

⚠ WARNING: PRIMER AND POWDER RESIDUE IS DANGEROUS WHEN EXPOSED TO HEAT, IMPACT AND/OR STATIC ELECTRICITY.

REMOVING THE PIGGYBACK

⚠ WARNING: NEVER ATTEMPT TO REMOVE THE PIGGYBACK WHILE POWDER OR PRIMERS REMAIN IN THE UNIT.

The Piggyback can be removed and reinstalled as one unit. First, remove the powder measure and the primer tube. To remove the Piggyback, lower the press handle to make the lock nut accessible. Loosen the lock nut slightly with a wrench. Raise the handle enough to allow removal of the ram adaptor. The twist in the index rod will hold the ram up to provide room to remove the lock nut with your fingers. Unscrew the lock nut from the bottom plate. Now, you can lift the entire unit off of the press. Simply reverse this procedure to re-install the Piggyback.

CALIBER CHANGE-OVER CHECK LIST

Changing calibers on the Piggyback is really quite simple. Here is a list of steps that may be required to change the Piggyback from one caliber to another.

- Remove the reloading die set and replace with the new caliber.
- Change the shell plate, if necessary.
- Change the primer dispenser, primer plug, transfer bar, and primer tube from large to small or small to large, if necessary.
- Adjust the primer seating depth.
- Adjust the primer transfer bar.
- Remove the powder drop tube from the powder measure adaptor and replace with the correct size.
- Adjust the powder measure to dispense the correct powder charge. Be sure to use an accurate reloading scale to weigh the new powder charge.
- Adjust the case eject spring.

Refer to the various sections in this manual for instructions to assemble and disassemble the priming and powder charging systems.

PIGGYBACK EXPLODED VIEW

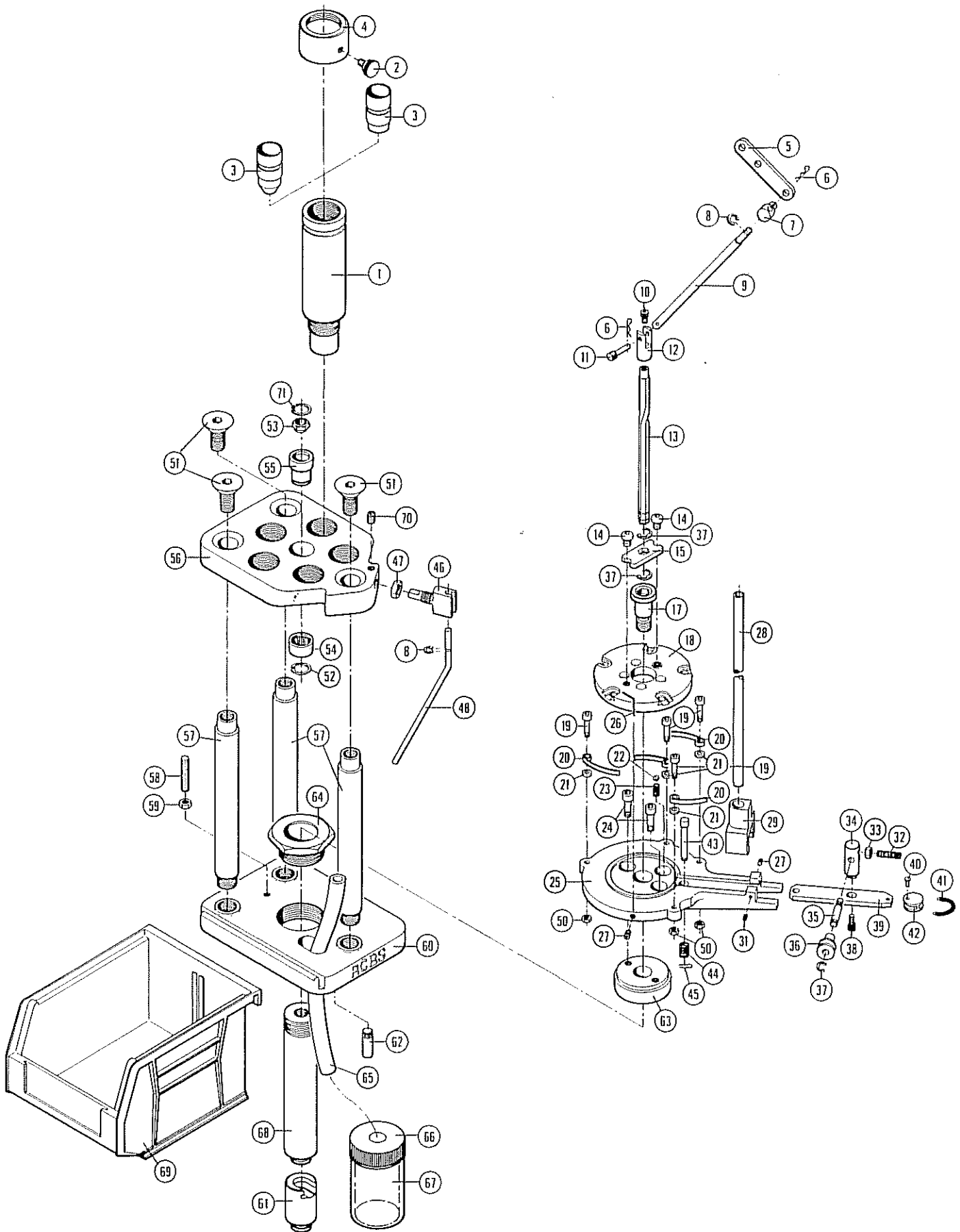

PIGGYBACK PARTS LIST

KEY	PART #	DESCRIPTION	KEY	PART #	DESCRIPTION
1	88030	Powder Measure Adaptor	37	87657	Retaining Ring
2	00000	Collar Lock Screw	38	87687	Capscrew 10-32x1/4
3	87191	Powder Drop Tube, Small Rifle	39	88016	Transfer Bar, Large
3	87193	Powder Drop Tube, Pistol	39	88015	Transfer Bar, Small
4	88050	Quick-change Collar	40	88018	Spring Retainer Pin
5	87677	Cylinder Handle	41	88019	Return Spring
6	09599	Cotter Pin	42	88017	Spring Retainer
7	87679	Connecting Yoke	43	88013	Primer Plug, Large
8	87670	Retaining Ring	43	88012	Primer Plug, Small
9	88029	Connecting Rod	44	88014	Primer Plug Spring
10	87687	Capscrew 10-32x1/4	45	88042	Hairpin Clip
11	87678	Cross Pin	46	88026	Cam Wire Clip
12	87676	Swivel	47	88027	Hex Nut 3/8-24
13	88010	Index Rod	48	88025	Cam Wire
14	88041	Capscrew 8-32x1/4	50	87157	Hex Nut 6-32
15	88003	Connecting Plate	51	88032	Flathead Socket Screw 3/8-16x3/4
17	88009	Ram Shoulder Bolt	52	09143	Retaining Ring
18	*	Shell Plate	53	87650	Nylon Bushing
19	98964	Capscrew 6-32x5/8	54	87653	Clutch Bearing
20	88039	Case Retaining Spring	55	87651	Inner Race
21	87157	Hex Nut 6-32	56	88001	Top Plate
22	87152	Index Ball	57	88008	Support Rod
23	88037	Index Ball Spring	58	88033	Setscrew 1/4-28x1 1/4
24	87159	Capscrew 1/4-28x3/4	59	87175	Hex Nut 1/4-28
25	88000	Shell Plate Holder	60	88002	Bottom Plate
26	88038	Case Eject Spring	61	88004	Ram Adaptor
27	88043	Setscrew 4-40x1/4	62	88011	Rock Chucker Locating Pin
28	88024	Primer Tube, Large	63	88006	Shell Plate Holder Adaptor
28	88023	Primer Tube, Small	64	88007	Piggyback Lock Nut
29	88045	Primer Dispenser, Large	65	88028	Spent Primer Tube
29	88044	Primer Dispenser, Small	66	87178	Spent Primer Bottle Cap
31	88036	Flathead Screw 4-40x1 1/8	67	87177	Spent Primer Bottle
32	88034	Setscrew 8-32x3/4	68	88005	Upper Ram
33	88035	Hex Nut 8-32	69	88031	Ammo Catcher Box
34	88021	Roller Carrier	70	09099	Setscrew 10-32x1/4
35	88022	Roller Carrier Pin	71	87654	Retaining Ring
36	88020	Roller			

*Order shell plate by shell plate number.
See the chart on page 7.



Your Shooting Partner

CCI,[®] Speer,[®] RCBS,[®] Outers[®] & Weaver[®]

We think that we make the very best reloading equipment in the world.

If you agree, please tell your friends.

If you disagree, tell us - we want to do something about it!

For Customer Service, call toll free: 1-800-533-5000 in the Continental U.S.

In other areas, phone (916) 533-5191.

Hours: Monday-Thursday 6:30 A.M. - 4:30 P.M.

OMARK SPORTING EQUIPMENT DIVISION OF BLOUNT, INC.

RCBS Operations, 605 Oro Dam Blvd., Oroville, CA 95965

FORM #200499-0489