

RCBS[®]

**RELOADER
SPECIAL-5
PRESS**

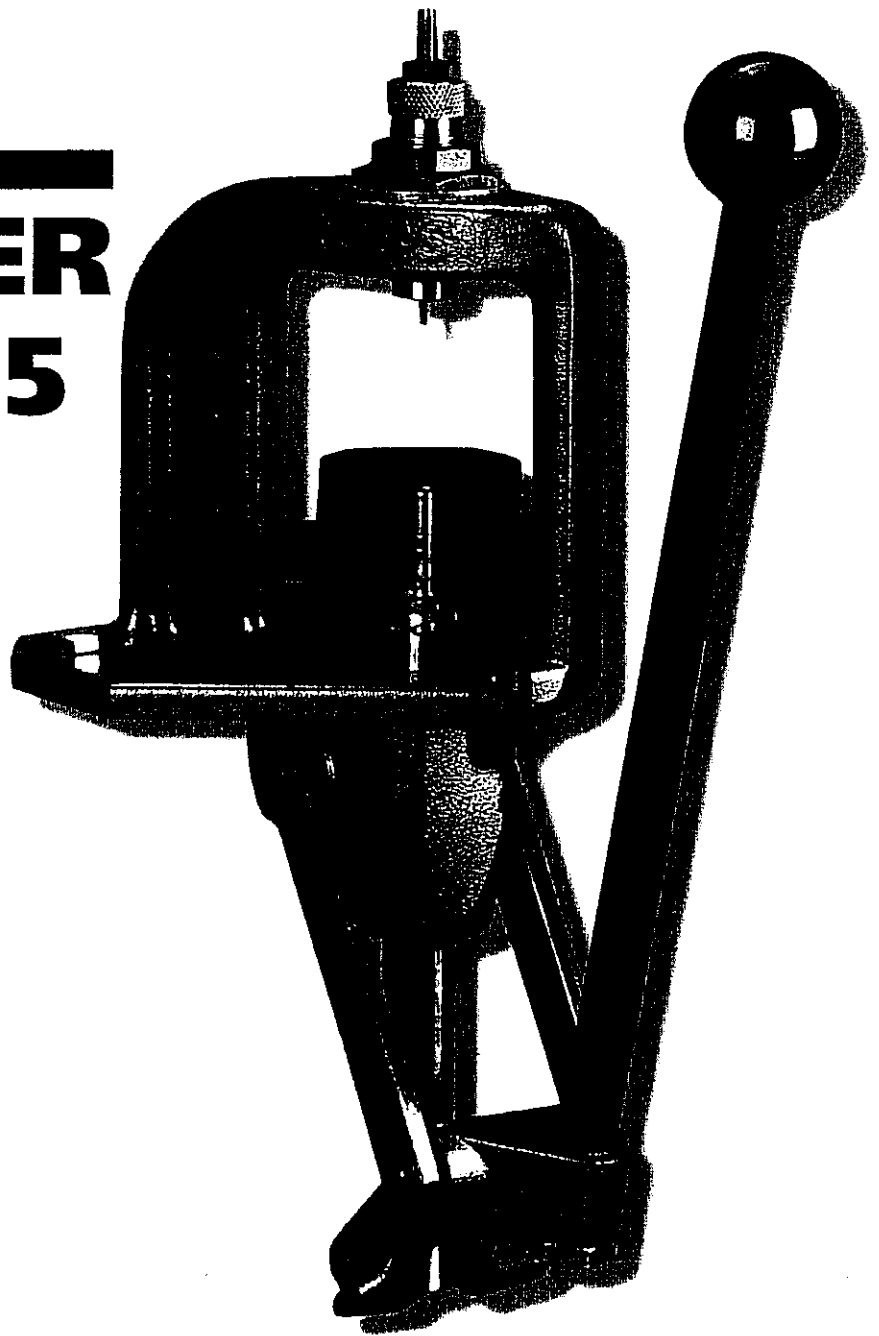

P R O D U C T I N S T R U C T I O N S

WARNING

- DO NOT attempt to prime military cartridge cases with crimped primer pockets until the crimp has been removed with a counter sink, a special reamer or by swaging. Primers seated into crimped pockets are subject to deformation which can cause misfires and even detonation during seating which can cause personal injury.
- DO NOT attempt to seat primers against excessive resistance which might cause detonation and possible personal injury. Check to be certain that the case was not previously primed, that the fired primer was removed, that a portion of the primer cup wall might still be in the primer pocket and that you are using the correct size primer.
- DO NOT modify the priming system in any manner or attempt to use similar parts or priming systems from other manufacturers. To do so could result in primer detonations resulting in personal injury.
- Primers not seated below the flush of the cartridge case head can result in a “slam fire”. This is a condition which the cartridge fires inadvertently as the gun mechanism is cycled. A “slam fire” can result in serious personal injury and equipment damage.
- DO NOT expose primers to heat, pressure or to static electricity. These conditions can cause primers to detonate.
- NEVER seat a primer into a powder charged case.
- Decapping live primers is extremely dangerous and is not recommended.

RELOADER SPECIAL-5 PRESS PARTS

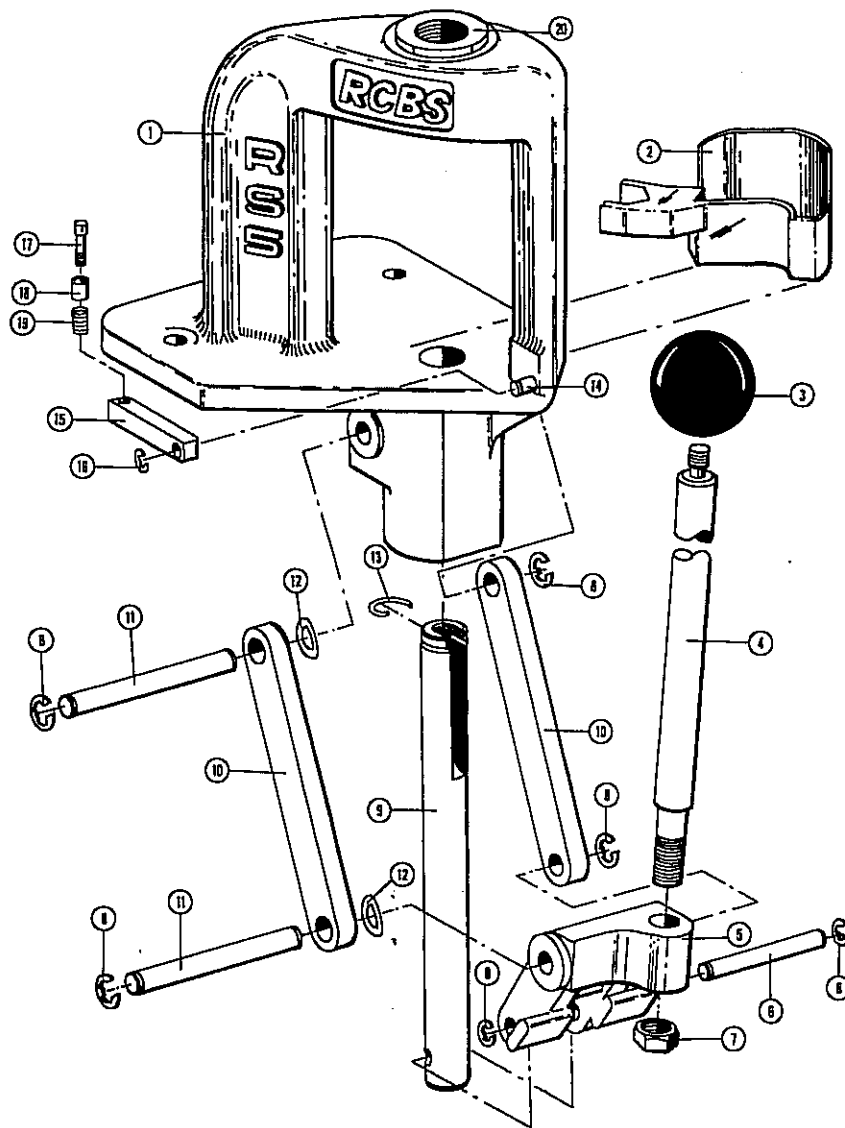

KEY	PART #	DESCRIPTION	KEY	PART #	DESCRIPTION
1	88205	Press Frame	13	09111	Shell Holder Ram Clip Spring
2	09268	Primer Catcher	14	87417	Primer Arm Pin
3	87414	Handle Ball	15	88210	Primer Arm
4	86860	Handle	16	87670	Retaining Ring
5	09258	Toggle	17	09554	Primer Plug, Large
6	09263	Ram Pin	17	09555	Primer Plug, Small
7	09265	Hex Nut, 9/16-18	18	09506	Primer Sleeve, Large
8	09266	Retaining Ring, 3/8" (6)	18	09507	Primer Sleeve, Small
9	88211	Ram	19	09508	Coil Spring
10	88215	Link (2)	20	09138	Bushing
11	88216	Link Pin (2)	-	09311	Case Lube-2
12	09260	Bow Washer, 3/8" (2)			

IMPORTANT: READ THIS SECTION FIRST

Before using the RCBS Reloader Special-5 Press, read these instructions carefully to fully learn how to safely operate the related reloading equipment. Failure to properly operate certain reloading equipment can result in severe personal injury and/or equipment damage. If you have read these instructions and still do not understand some operation, call us at 1-800-533-5000 and a technician will assist you. This instruction manual contains specific safety and operating information. It should be considered a permanent part of your reloading equipment and remain with the equipment at all times for easy reference.

SAFETY

Reloading is an enjoyable and rewarding hobby that can be conducted safely. But, as with any hobby, carelessness or negligence can make reloading hazardous. This product has been designed from the beginning with the user's safety in mind. When reloading, safety rules must be followed. By observing these rules, the chance of a hazardous occurrence causing personal injury or property damage is minimized.

GENERAL

- Use all equipment as the manufacturer recommends. Study the instructions carefully and become thoroughly familiar with the operation of the product. If you do not have written instructions, request a copy from the equipment manufacturer.
- Don't take short cuts. Attempting to bypass established procedures is an invitation to an accident.
- Observe "good housekeeping" in the reloading area. Keep tools and components neat, clean and orderly. Promptly and completely clean up primer and powder spills.
- Reload only when you can give your undivided attention. Do not reload when fatigued or ill, or under the influence of medications or alcohol. Develop a reloading routine to avoid mistakes which may prove hazardous. Don't rush - load at a leisurely pace.
- Always wear adequate eye protection to protect your eyes from flying particles. You assume unnecessary risk when reloading without wearing safety glasses.

LOADING DATA

- Use only laboratory tested reloading data. We highly recommend the current SPEER Reloading Manual.
- OBSERVE ALL WARNINGS ABOUT THE USE OF MAXIMUM LISTED LOADS.

PRIMERS AND POWDER

- Store primers and powder beyond the reach of children and away from heat, dampness, open flames and electrical equipment. Avoid areas where static electricity is evident.
- Do not use primers of unknown identity. Scrap unknown primers in accordance with applicable regulations.
- Keep primers in the original factory container until ready to use. Return unused primers to the same factory packaging for safety and to preserve their identity. Primer packaging is designed to provide safe storage.
- DO NOT store primers in bulk. The blast of just a few hundred primers is sufficient to cause serious injury to anyone nearby.
- DO NOT force primers. Use care in handling primers.
- DO NOT have more than one can of powder on the bench at one time. Powder cans should be stored away from the bench to avoid picking up the wrong one.
- DO NOT use any powder unless its identity is positively known. The only positive identification is the manufacturer's label on the original canister. Discard all mixed powders and those of uncertain identity.
- If you use a powder measure, replace the lids on both the powder hopper and powder can after the powder hopper has been filled.
- When using a powder measure, settle the powder in the powder hopper before charging any cases. Throw and check the weight of at least ten charges. This will assure you that the correct powder charge is being thrown.
- When you finish a reloading session, pour any remaining powder back into its original factory container. This will preserve the identity and shelf life of the powder.
- DO NOT smoke while reloading.

RECORD KEEPING

- Keep complete records of reloads. Apply a descriptive label to each box showing the date produced, and the primer, powder and bullet used. Labels for this purpose are packed with SPEER bullets.

Never attempt to guess at the identity of your ammunition.

Because RCBS has no control over the choice of components, the manner in which they are assembled, the use of this product, or the guns in which the resulting ammunition may be used, we assume no responsibility, expressed or implied, for the use of ammunition reloaded with this product.

The RCBS Reloader Special-5 (RS-5) Press is the perfect press for beginners, or experienced reloaders who want a separate press to handle different functions or calibers. It has evolved from the now famous "JR" and Reloader Special Presses. With the RS-5 you can reload your favorite pistol and rifle ammo from the magnum down to .17 caliber. The versatile RS-5 features an on-press primer arm and a removable bushing that allows the use of RCBS Shotgun Dies or the Piggyback Conversion Unit. The sturdy block "O" frame, pioneered by RCBS, eliminates springing of the frame that occurs in "C" and other type presses. The block "O" portion of the frame has been offset to allow easy access of the work area. The press frame has an extra-long ram-bearing surface to eliminate ram wobble and side-play and assures the alignment of the shell holder to the die. The RS-5 Press has standard 7/8-14 thread for most all popular reloading accessories. The toggle block, links and pins are engineered to prevent springing and breakage.

UNPACKING

Unpack the press carefully and look for the items listed below. Refer to the parts list for identification. The kit should contain the following items:

- Press
- Handle and handle nut
- Primer Catcher
- Primer Arm with Primer Plugs and Sleeves

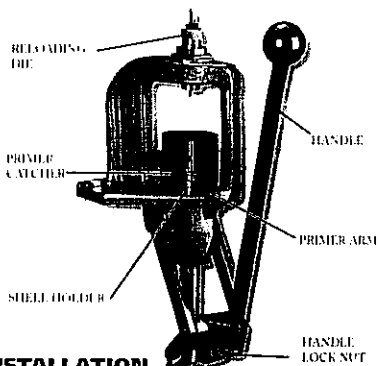

INSTALLATION

Solidly mount the Reloader Special-5 Press to a sturdy table or workbench with two 3/8" bolts of sufficient length to penetrate the press base and bench. We do not recommend using "C" clamps to mount the press to the reloading bench. Remove the handle nut from the handle and install the threaded portion through the toggle block as shown.

See photo 1.



Attach the handle nut and tighten securely. The handle nut must remain tight at all times to avoid damage to the handle and toggle block. To position the primer catcher as shown, snap the catcher onto the rear portion of the press frame and against the ram.

See photo 2.

The RS-5 Press accepts removable type shell holders. To install, insert the shell holder into the ram and twist slightly to the left. To remove the shell holder, twist slightly to the right while pulling the shell holder out of the slot.

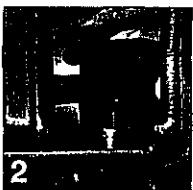

PRIMER ARM ASSEMBLY AND INSTALLATION

All the parts needed to assemble the primer arm are packaged in a plastic bag. Refer to the parts list in the back of this instruction manual for their identification. Before installing the primer arm onto the press, make sure the correct size primer plug and sleeve are in position on the primer arm. To assemble: Select the correct primer plug and sleeve (large or small). Drop the primer plug through the sleeve. Place the coil spring onto the end of the primer plug. Screw the threaded end of the primer plug into the counterbored side of the primer arm.



Tighten the assembly with a small nail or straightened paper clip through the cross hole in the primer plug. Do not over tighten. To install the primer arm assembly, insert the primer arm pin (the end without the groove) into the hole in the press frame. Gently tap the end of the pin with a small hammer until the small shoulder on the pin seats up against the press frame. Slide the primer arm assembly over the pin until the groove on the pin is exposed. Install the retaining ring.

See photo 4.

be changed without removing the primer arm assembly from the press. Check from time to time to be certain the primer plug remains tight.

MAINTENANCE

This press was lubricated at the factory. However, it is necessary to lubricate all moving parts from time to time with a light oil such as *Outers Gun Oil*. If rust spots appear, swab lightly with gun oil and wipe dry. Care should be taken not to apply it where it could come in contact with primer pockets

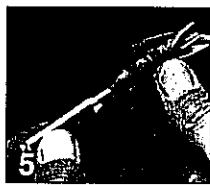

or primers. Oil will deactivate primers. It is a good practice to clean the press prior to lubrication to remove grit and other residue. You will note the ease at which the epoxy enamel paint wipes clean. This finish is impervious to oil and is extremely chip and fade resistant.

RELOADING WITH A 2-DIE SET (BOTTLENECK RIFLE AND PISTOL CASES)

STEP 1. Wipe all the cases clean to prevent dirt and grit from scratching the cases and the interior of the sizer die. Using a deburring tool, remove any rough edges from the inside and outside of the case mouth. Inspect the cases for any defects such as case separations and split necks. Crush and discard any defective cases.

See photo 5.

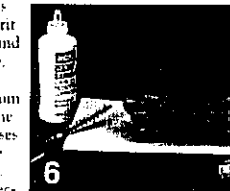

STEP 2. Lightly lubricate the outside of the cases by rolling them over the case lube pad that has a trace of *Case Lube-2* on it. This will permit the case to be inserted into the sizer die without sticking. Apply a trace of lubricant to the case neck brush by rolling it over the case lube pad and lightly lubricate the inside of the case neck.

See photo 6.

NOTE: If you apply too much lube, it can cause dents in the shoulder of the case during resizing. If there isn't enough lube, the case can become stuck in the sizer die.

STEP 3. Screw the sizer die into the top of the reloading press. Refer to the die instructions that were included with your reloading dies for the proper adjustment. Install the

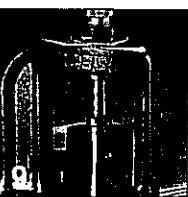

correct shell holder into the ram. See photo 7.

STEP 4. Raise the press handle and slide the case into the shell holder. Gently but firmly, lower the press handle and run the case all the way into the die. This operation will resize the case, expand the case mouth and knock the fired primer out of the bottom of the case. See photo 8.

STEP 5. While the case is still inside the die, insert a live primer, open end up, into the cup of the primer arm. Gently and slowly raise the press handle. As the case is drawn out of the die, it will be lowered onto the live primer. Inspect the primer to make sure it is properly seated. Ideally, the primer should be seated .002 to .005 below flush. Develop the habit of checking each case after it is primed. See photo 9.

STEP 6. Consult the *Spec Reloading Manual* to learn what kind of powder, and how much, is needed to reload your caliber of cartridge. Then weigh the recommended powder charge in your reloading scale. Follow the instructions you received with your scale for proper adjustment. See photo 10.



STEP 7. After you have accurately weighed the powder, it can be poured into the case through the powder funnel. See photo 11.

the final step of reloading the case and seating the bullet. Unscrew the sizer die from the press and thread the seater die into the press. Adjust the seater die according to the instructions received with your die set. See photo 12.



STEP 9. Insert a case into the shell holder and holding a bullet over the mouth of the case with one hand, lower the press handle with the other. Run the bullet and case into the seater die. Adjust the seater plug up or down to achieve the proper seating depth. See photo 13.



NOTE: For simplicity, these instructions show just one case going through all the reloading steps. In actual reloading you would take a quantity of cases through each step.

RELOADING WITH A 3-DIE SET (STRAIGHT-WALL RIFLE AND PISTOL CASES)

Reloading with a 3-Die Set is basically the same as reloading with a 2-Die Set, except the expanding step is done in a separate die.

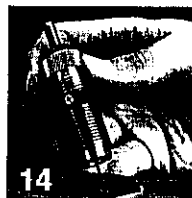

STEP 1. Refer to Step 1 for 2-Die Set. See photo 5.

STEP 2. Refer to Step 2 for 2-Die Set. See photo 6.

STEP 3. Refer to Step 3 for 2-Die Set. See photo 14.

STEP 4. Raise the press handle and slide the case into the shell holder. Gently but firmly lower the press handle and run the case all the way into the die. This operation will resize the case and knock the fired primer out of the bottom of the case. After running the case all the way into the die, insert a live primer, open end up, into the cup of the primer arm. Gently and slowly raise the press handle. As the case is drawn out of



the die, it will be lowered onto the live primer. Inspect the primer to make sure it is properly seated. Ideally, the primer should be seated .002 to .005 below flush. Develop the habit of checking each case after it is primed. See photo 15.

STEP 5. Unscrew the sizer die from the press and replace it with the expander die. This die will expand the case mouth to receive the bullet. Refer to your die instructions for proper adjustment. See photo 16.



STEP 6. Consult the *Spec Reloading Manual* to learn what kind of powder, and how much, is needed to reload your caliber of cartridge. Then weigh the recommended powder charge in your reloading scale. Follow the instructions you received with your scale for proper adjustment. See photo 17.

STEP 7. After you have accurately weighed the powder, it can be poured into the case through the powder funnel. See photo 18.



STEP 8. You are now ready for the final step of reloading the case and seating the bullet. Unscrew the expander die from the press and thread the seater die into the press. Adjust the seater die according to the instructions received with your die set. Insert a case into the shell holder, and holding a bullet over the mouth of the case with one hand, lower the press handle with the other. Run the bullet and case into the seater die.

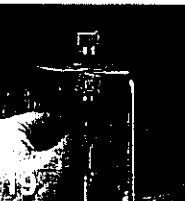

Adjust the seater plug up or down to achieve the proper seating depth. See photo 19.

NOTE: For simplicity, these instructions show just one case going through all its reloading steps. In actual reloading, you would take a quantity of cases through each step.

RCBS

PRECISIONEERED® RELOADING EQUIPMENT

*We think that we make the very best
reloading equipment in the world.
If you agree, please tell your friends.
If you disagree, tell us - we want to do something about it!*

Customer Service

1-800-533-5000 (US or Canada) or 530-533-5191

Hours: Monday - Friday, 6:30am - 4:00pm Pacific Time

e-mail: rcbstech@atk.com • www.rcbs.com

RCBS • 605 Oro Dam Blvd. • Oroville, CA 95965

CCI • SPEER • RCBS
OUTERS • RAMLINE • ORBEX • FEDERAL

200510/0404